

QCD's phase diagram from DSEs

Christian S. Fischer

Justus Liebig Universität Gießen

JINR Dubna 2018

CF, Mueller, PRD 84 (2011) 054013

CF, Luecker, PLB 718 (2013) 1036,

CF, Luecker, Welzbacher, PRD 90 (2014) 034022

Eichmann, CF, Welzbacher, PRD93 (2016) [1509.02082]

Review: CF, in preparation



Bundesministerium
für Bildung
und Forschung

HIC | **FAIR**
for
Helmholtz International Center

1. Introduction

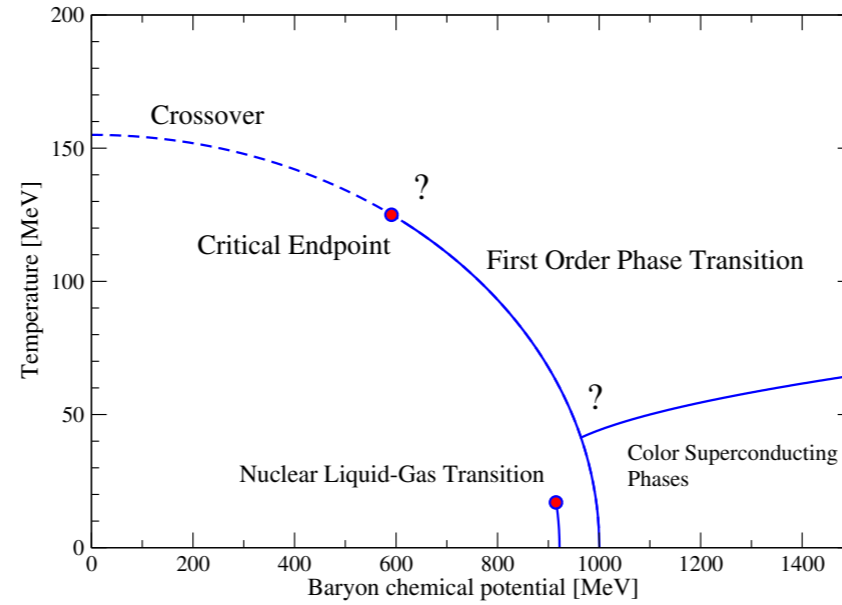

2. Gluons, quarks and the CEP

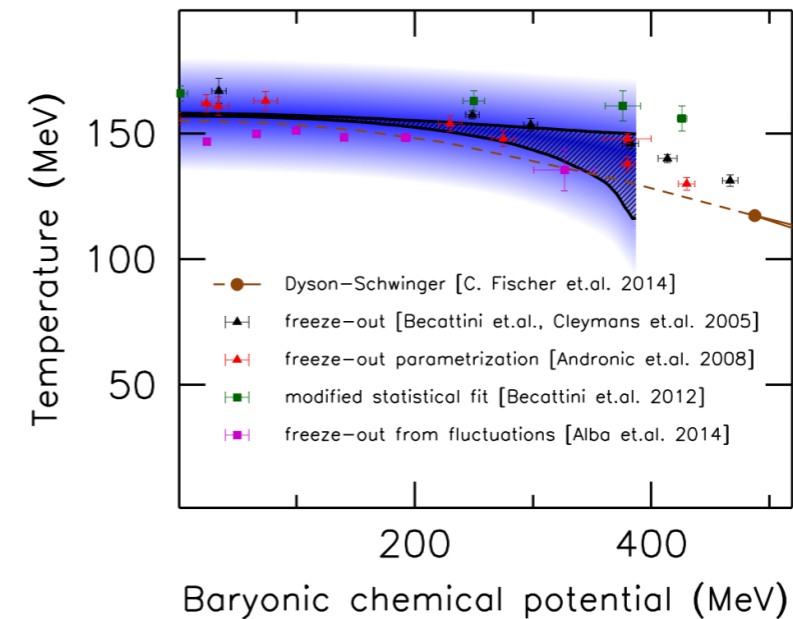

3. Hadron effects on the phase diagram

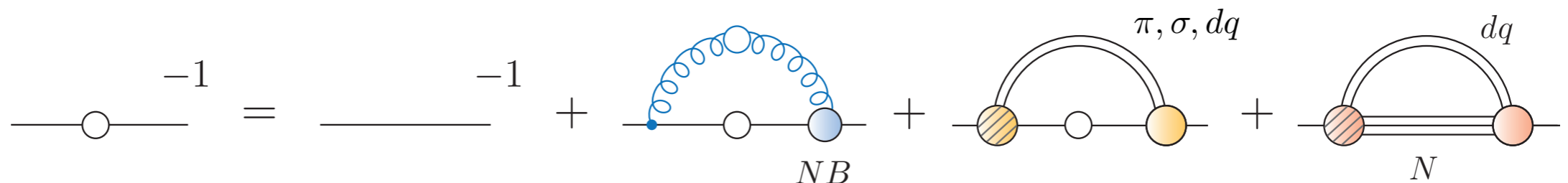

QCD phase transitions

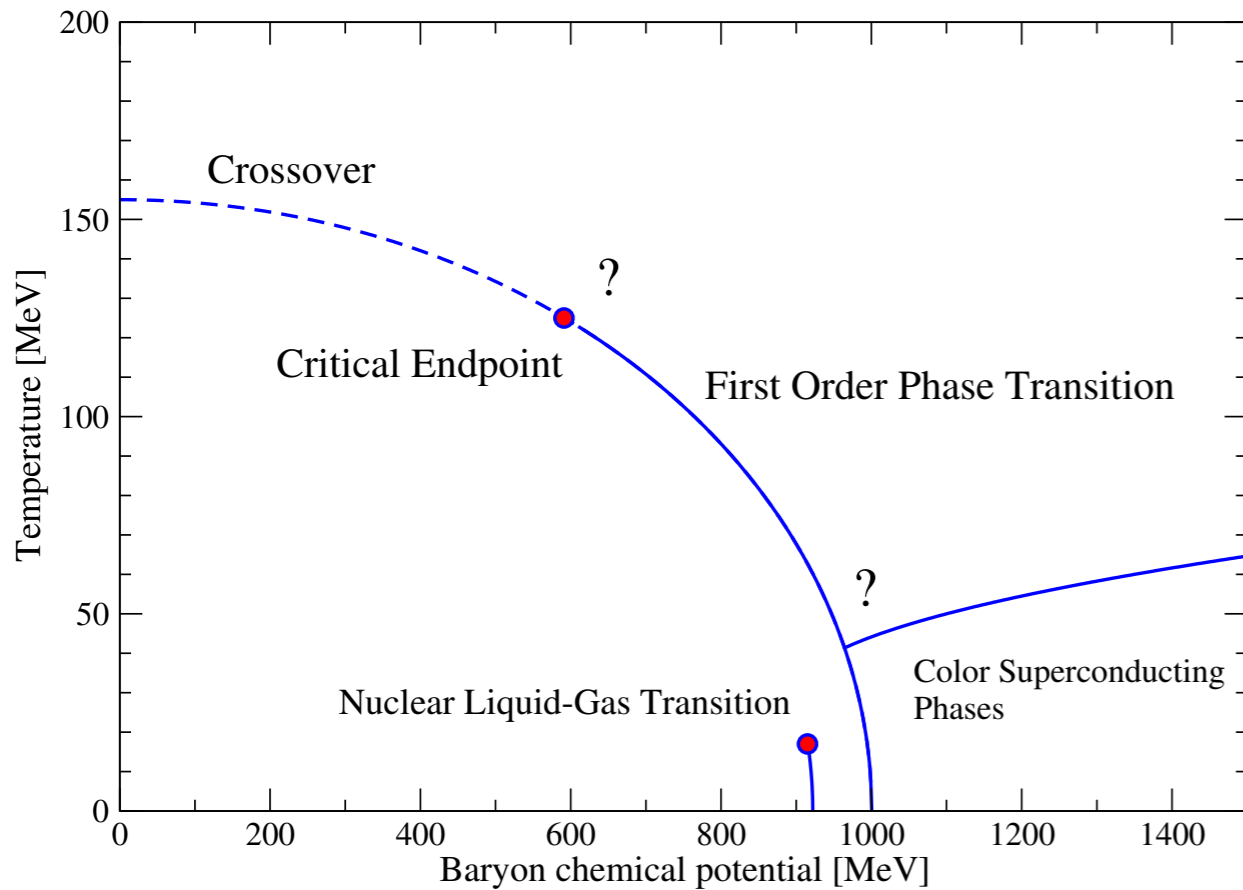

$$Z\left(\frac{\mu_B}{T}\right) = Z\left(-\frac{\mu_B}{T}\right)$$

$$\left(\frac{T(\mu_B)}{T_c}\right)^2 = 1 + 2\kappa \left(\frac{\mu_B}{T_c}\right)^2$$

QCD phase transitions

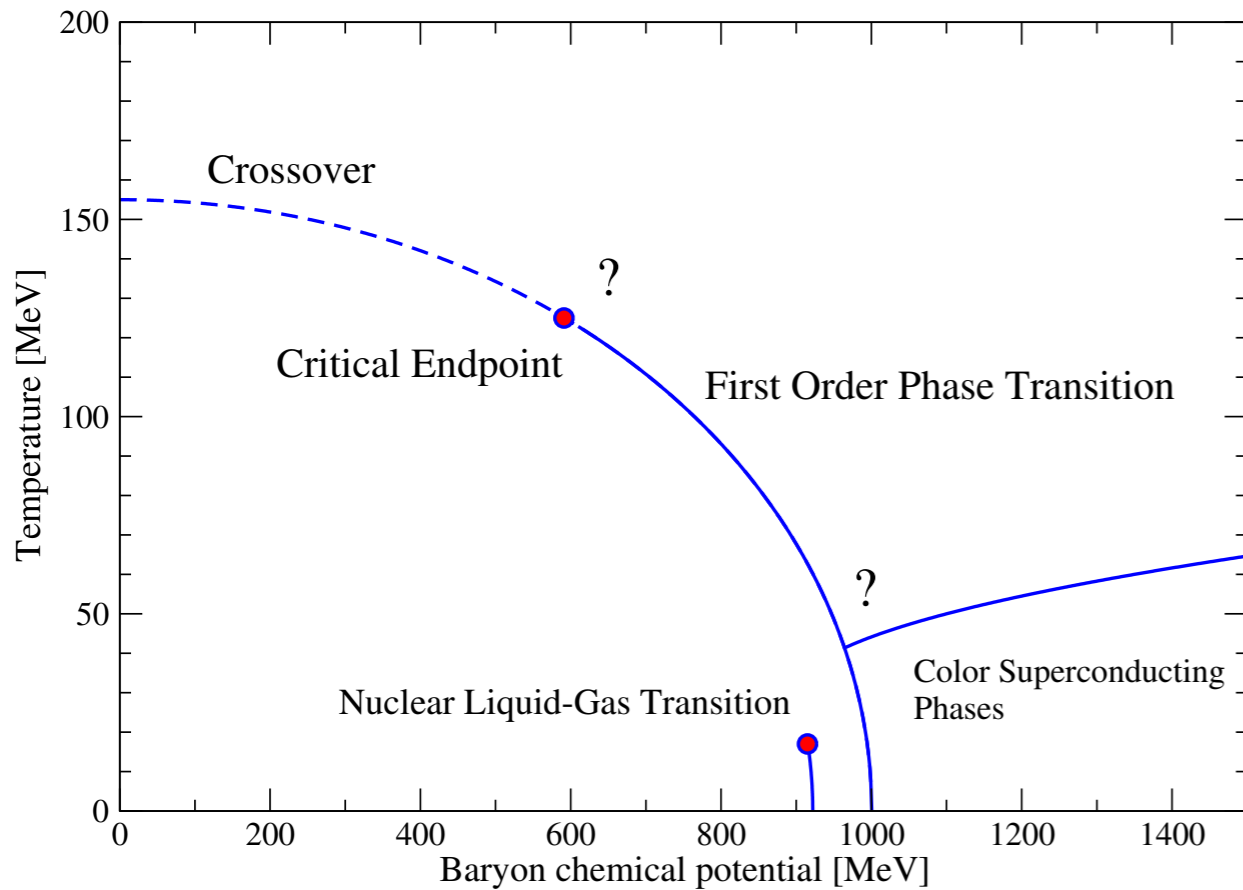

$$Z\left(\frac{\mu_B}{T}\right) = Z\left(-\frac{\mu_B}{T}\right)$$

$$\mu_B^{lg} \approx 922 \text{ MeV} \rightarrow \kappa \leq 0.0141$$

$$\left(\frac{T(\mu_B)}{T_c}\right)^2 = 1 + 2\kappa \left(\frac{\mu_B}{T_c}\right)^2$$

QCD phase transitions

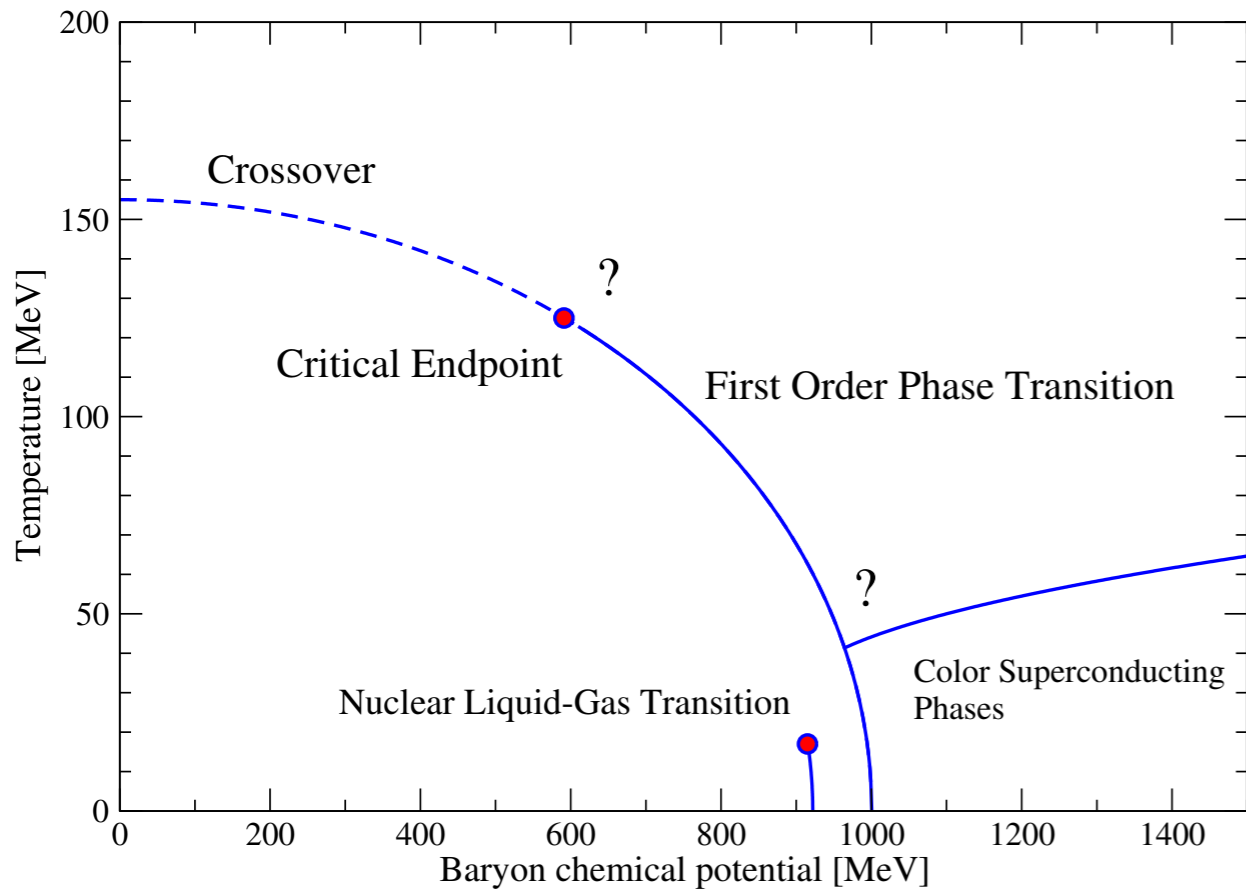

$$Z\left(\frac{\mu_B}{T}\right) = Z\left(-\frac{\mu_B}{T}\right)$$

$$\left(\frac{T(\mu_B)}{T_c}\right)^2 = 1 + 2\kappa \left(\frac{\mu_B}{T_c}\right)^2$$

$$\mu_B^{lg} \approx 922 \text{ MeV} \rightarrow \kappa \leq 0.0141$$

$$\text{Lattice QCD: } \kappa = 0.0145(25)$$

Bonati et al., arXiv:1805.02960

QCD phase transitions

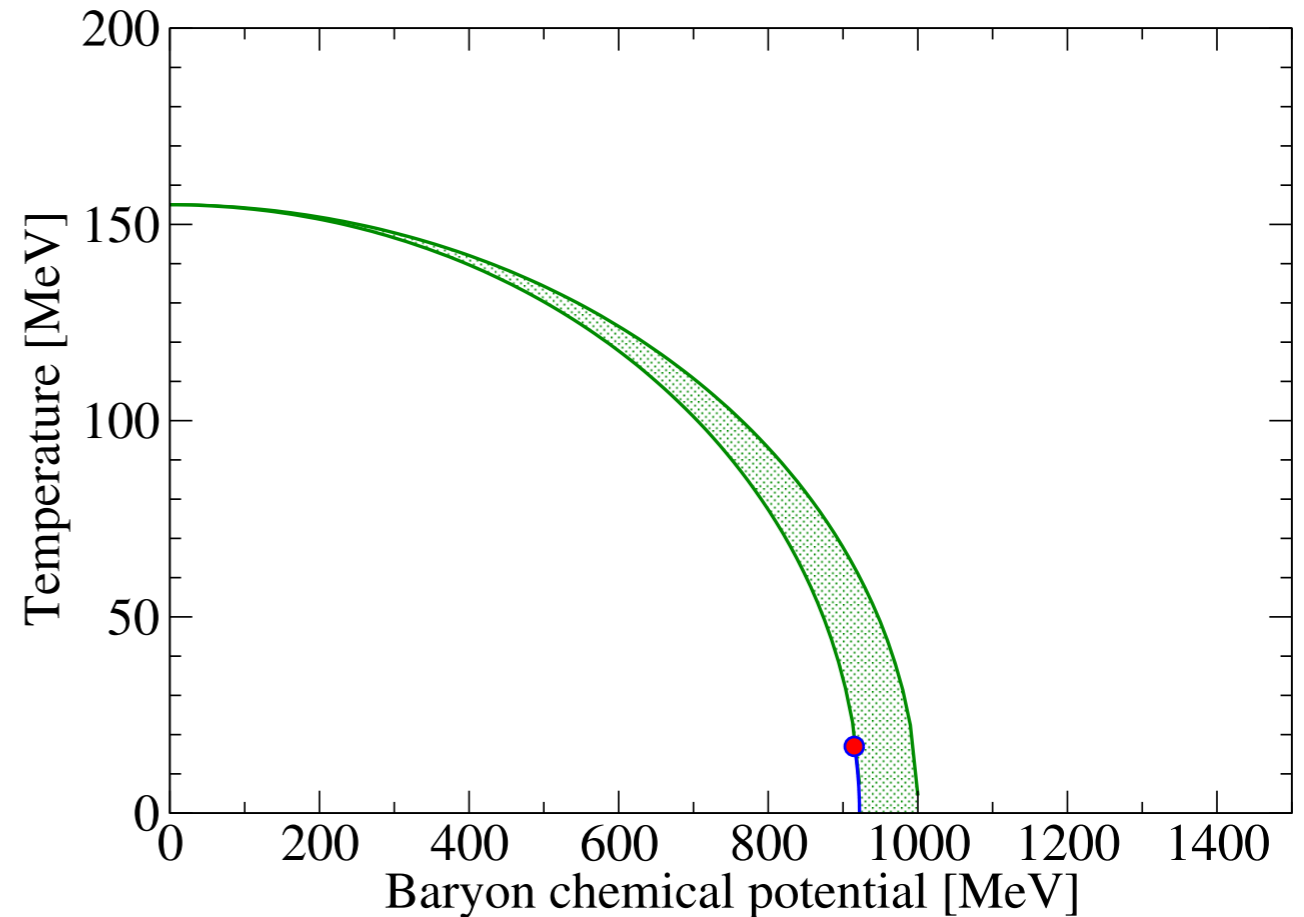
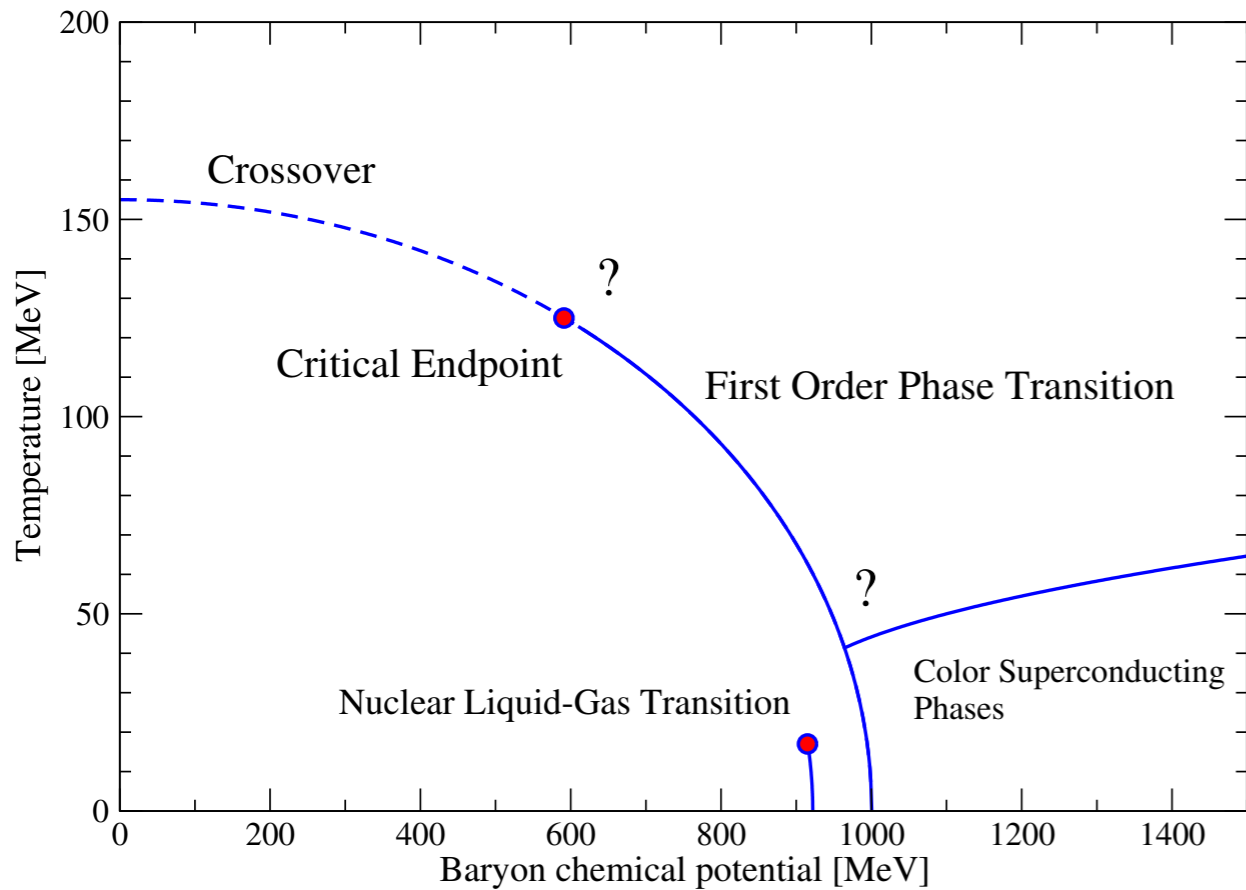

$$Z\left(\frac{\mu_B}{T}\right) = Z\left(-\frac{\mu_B}{T}\right)$$

$$\left(\frac{T(\mu_B)}{T_c}\right)^2 = 1 + 2\kappa \left(\frac{\mu_B}{T_c}\right)^2$$

$$\mu_B^{lg} \approx 922 \text{ MeV} \rightarrow \kappa \leq 0.0141$$

$$\text{Lattice QCD: } \kappa = 0.0145(25)$$

Bonati et al., arXiv:1805.02960

QCD phase transitions

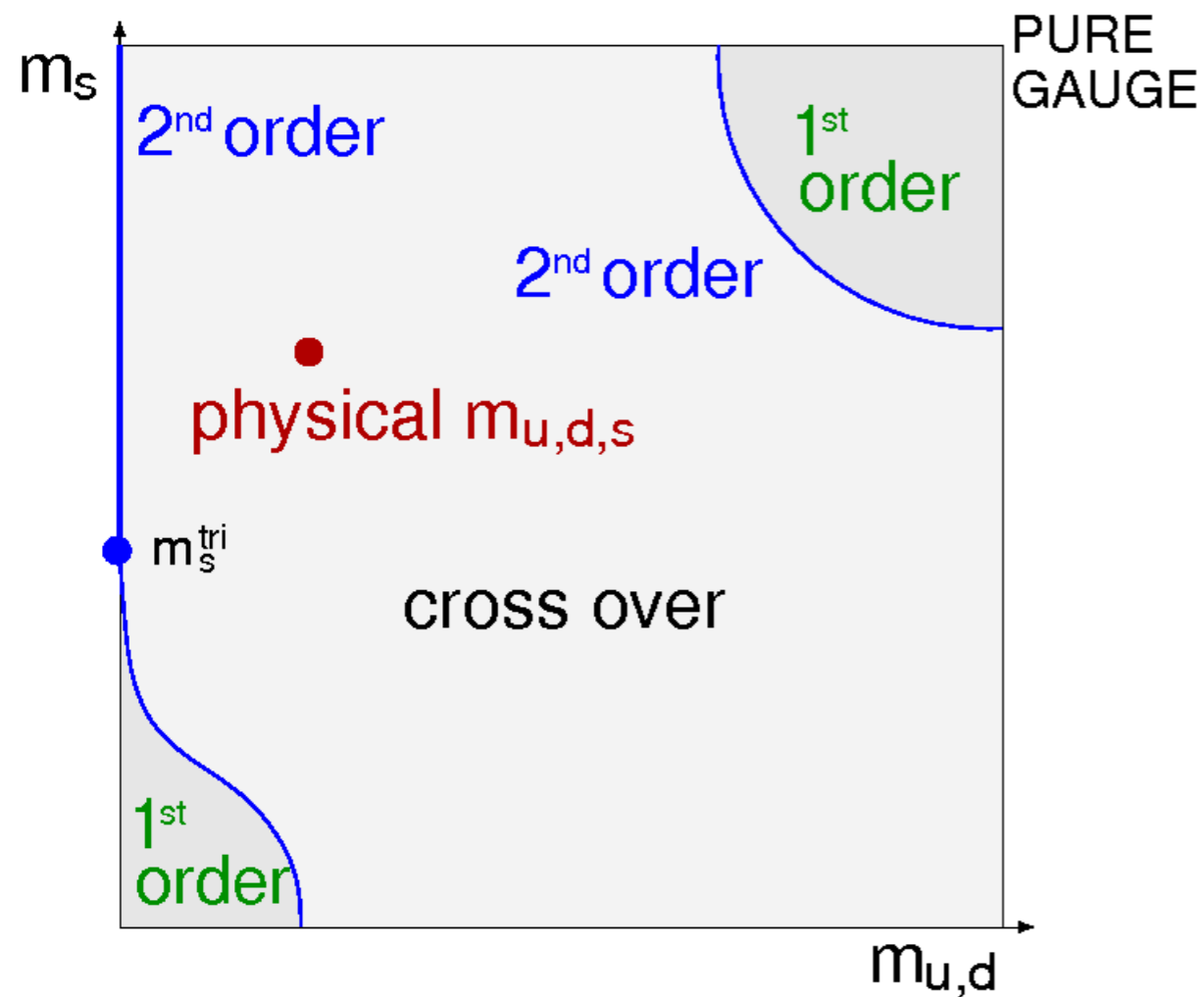

Is this happening ??
Maybe yes, maybe not..

de Forcrand, Philipsen, JHEP 0811 (2008) 012;
NPB 642 (2002) 290

QCD phase transitions

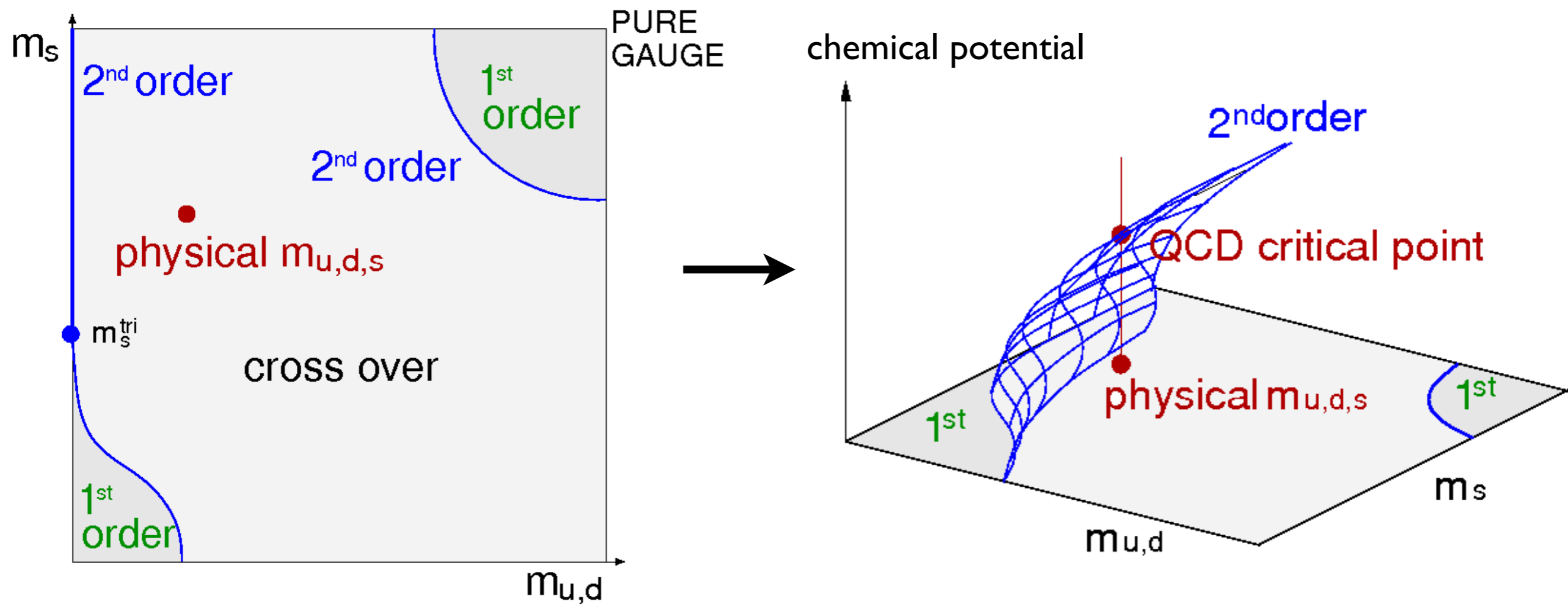

Is this happening ??
Maybe yes, maybe not..

de Forcrand, Philipsen, JHEP 0811 (2008) 012;
NPB 642 (2002) 290

QCD phase transitions

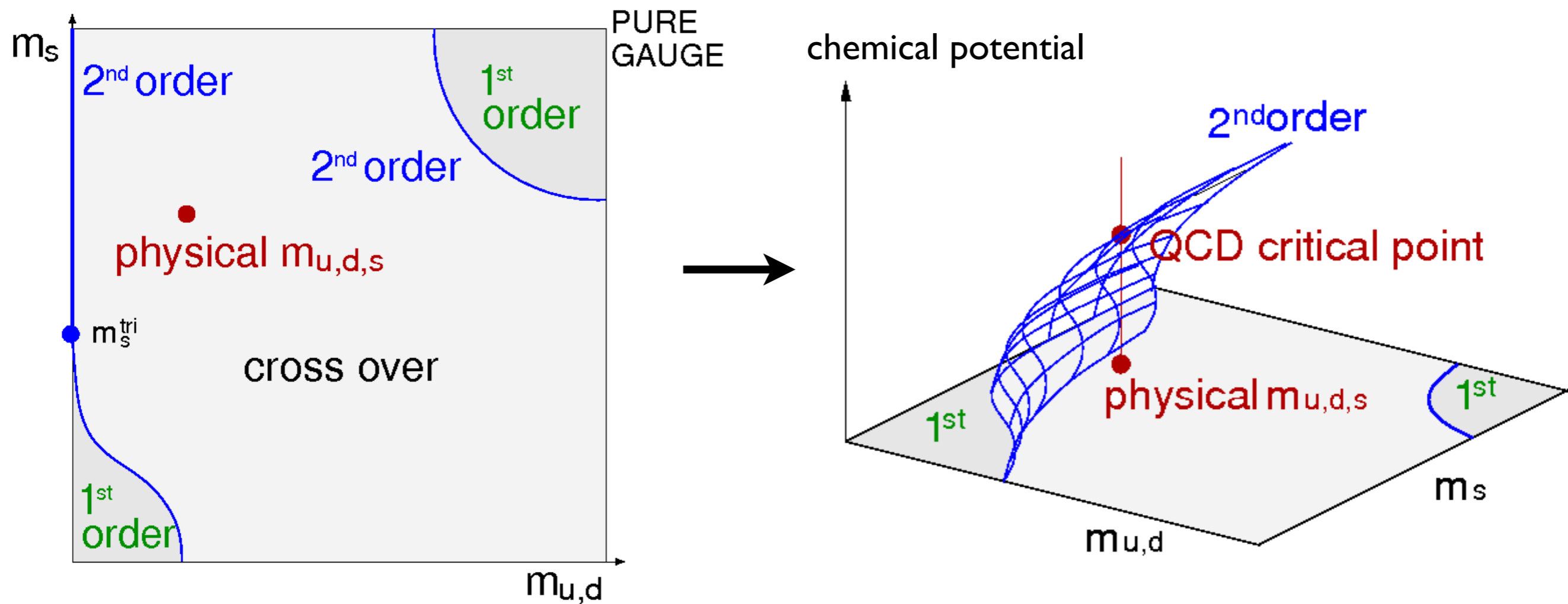

- Lattice-QCD
 - present: extrapolation
 - future: exact methods ?
- DSE/FRG
 - not exact, but allow for '10%-physics'

Is this happening ??
Maybe yes, maybe not..

de Forcrand, Philipsen, JHEP 0811 (2008) 012;
NPB 642 (2002) 290

Chiral transition line from analytic continuation

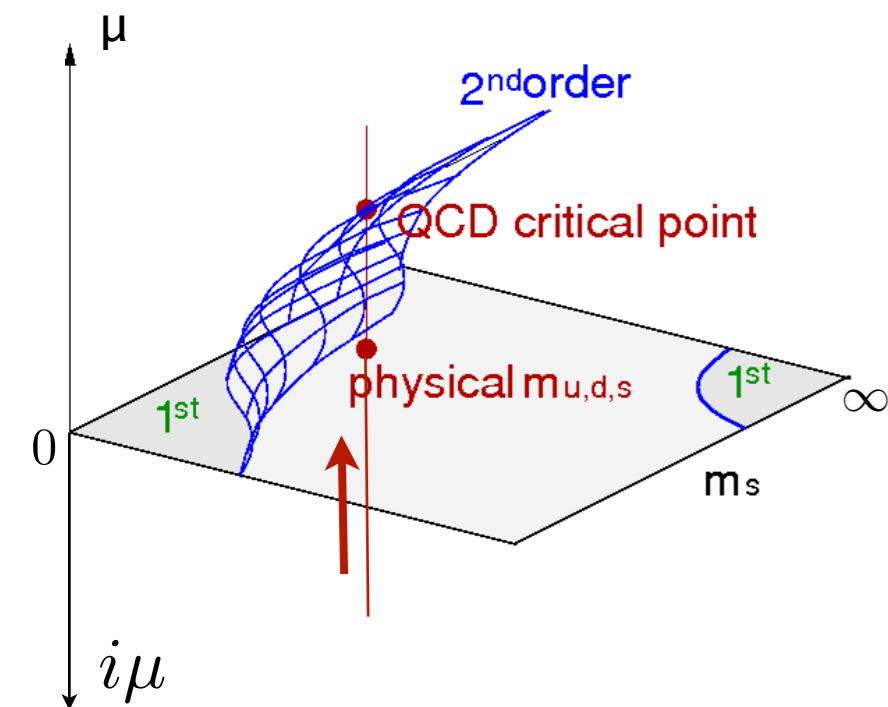

Temperature (MeV)

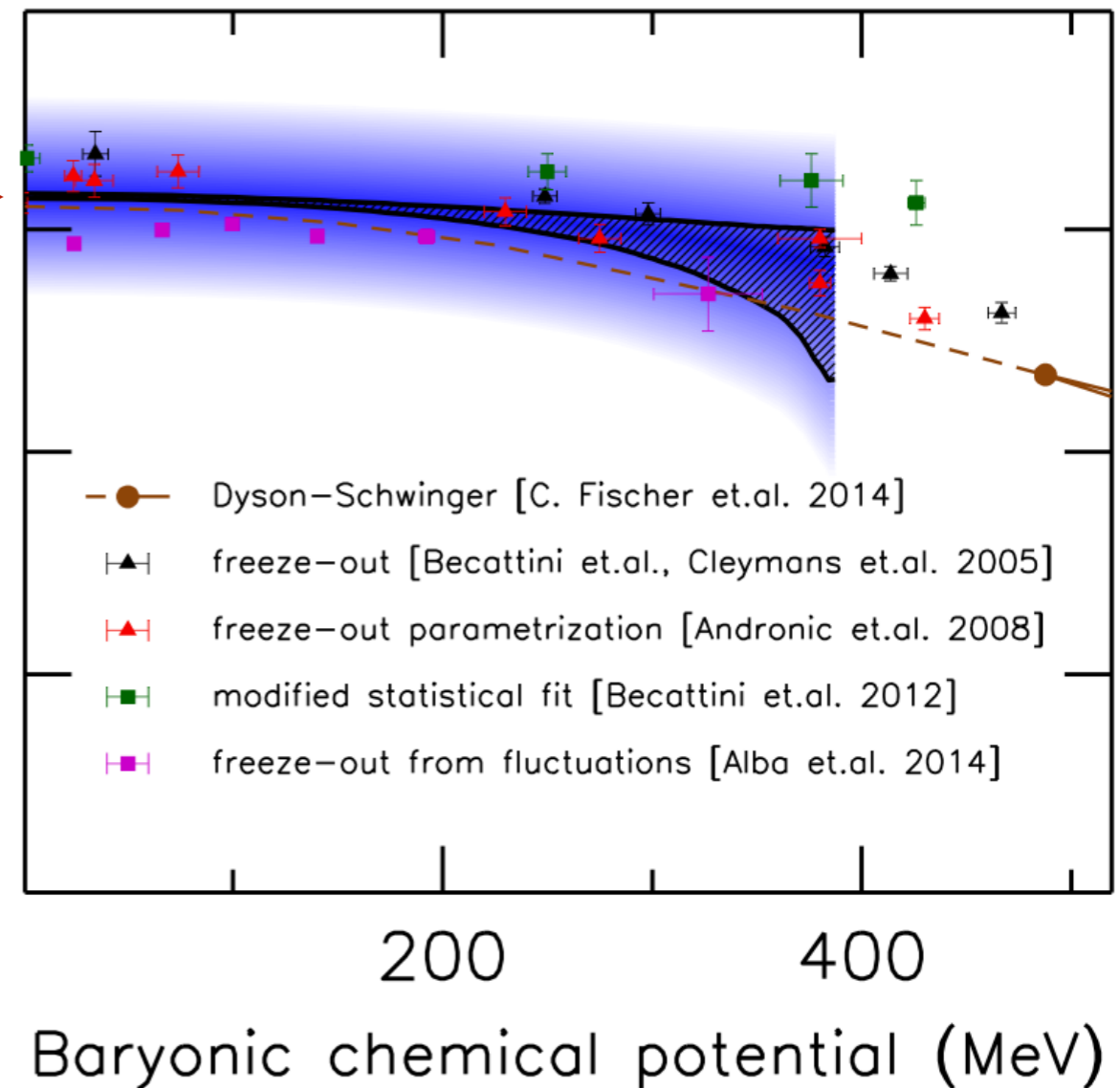

Lattice method:

- Det. crossover at imaginary μ and extrapolate to real μ
- Control systematics

Main result:

- No transition for $\mu_B/T < 2-3$

Bellwied, Borsanyi, Fodor, Günther,
Katz, Ratti and Szabo, PLB 751 (2015) 559

1. Introduction

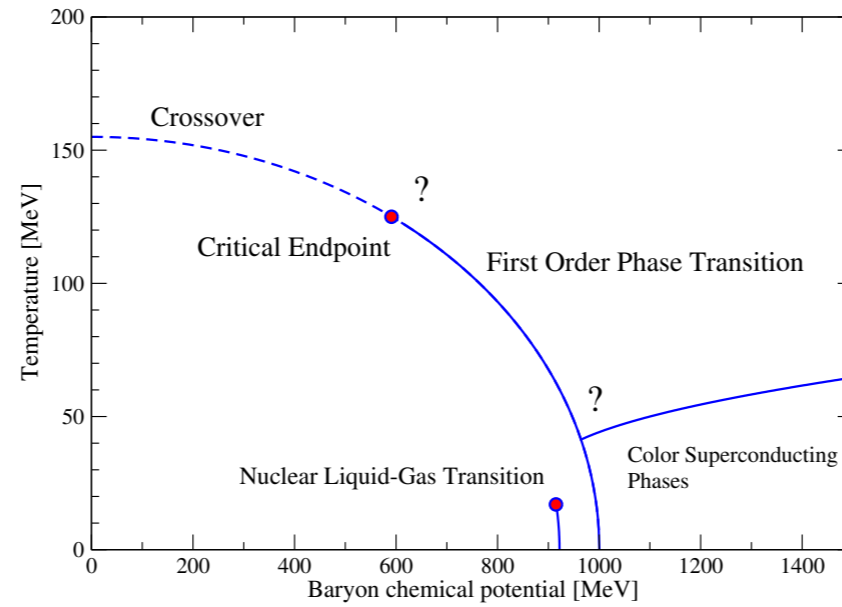

2. Gluons, quarks and the CEP

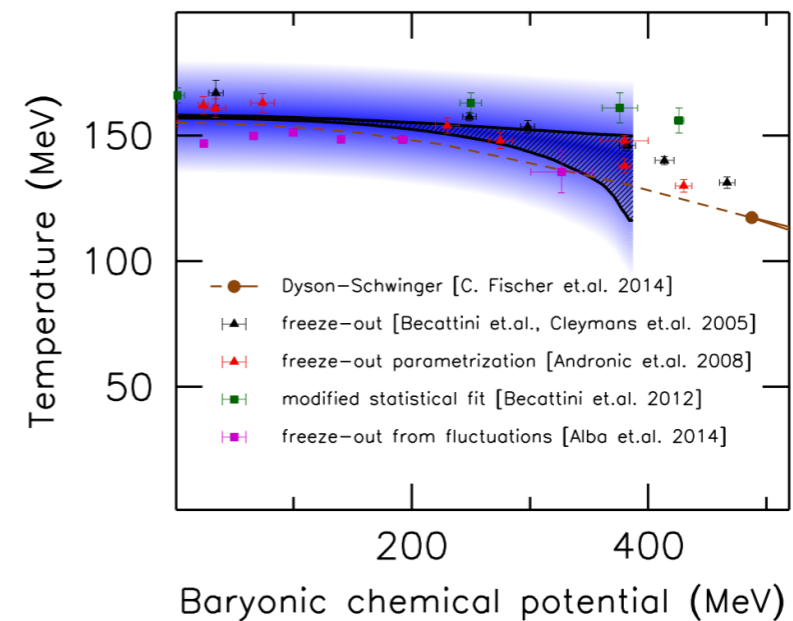

3. Hadron effects

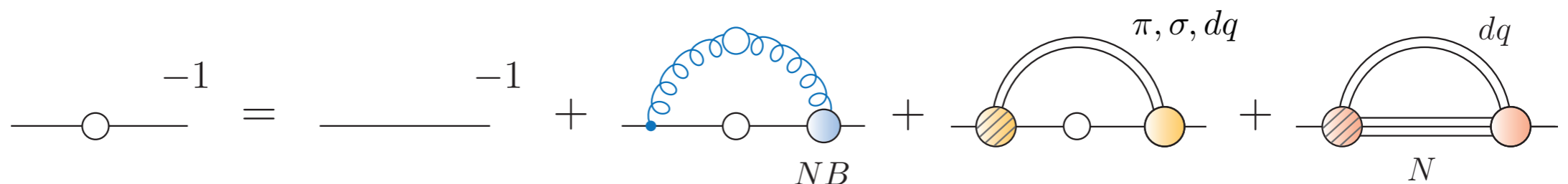

QCD order parameters from propagators

Chiral order parameter:

$$\langle \bar{\Psi} \Psi \rangle = Z_2 N_c \text{Tr}_D \frac{1}{T} \sum_{\omega} \int \frac{d^3 p}{(2\pi)^3} S(\vec{p}, \omega)$$

Deconfinement:

- dressed Polyakov loop

$$\Sigma = - \int_0^{2\pi} \frac{d\varphi}{2\pi} e^{-i\varphi} \langle \bar{\Psi} \Psi \rangle_{\varphi}$$

Synatschke, Wipf, Wozar, PRD 75, 114003 (2007)
 Bilgici, Bruckmann, Gattringer, Hagen, PRD 77 094007 (2008)
 CF, PRL 103 052003 (2009)

- Polyakov loop potential

$$L = \frac{1}{N_c} \text{Tr} e^{ig\beta A_0}$$

$$\frac{\delta(\Gamma - S)}{\delta A_0} = \frac{1}{2} \left(\text{Diagram 1} - \text{Diagram 2} - \text{Diagram 3} - \frac{1}{6} \text{Diagram 4} + \text{Diagram 5} \right)$$

Braun, Gies, Pawłowski, PLB 684, 262 (2010)
 Braun, Haas, Marhauser, Pawłowski, PRL 106 (2011)
 Fister, Pawłowski, PRD 88 045010 (2013)
 CF, Fister, Luecker, Pawłowski, PLB 732 (2013)

The DSE for the quark propagator

$$\text{---} \circ \text{---}^{-1} = \text{---}^{-1} - \text{---} \circ \text{---} \circ \text{---}$$

Two strategies: I. use **model** for gluon

Qin, Chang, Chen, Liu and Roberts, PRL 106 (2011) 172301

Y. Jiang, L.-J. Luo, and H.-S. Zong, JHEP 02 (2011) 066

Gutierrez, Ahmad, Ayala, Bashir and Raya, JPG 41 (2014) 075002

C. Shi, Y.-L. Du, S.-S. Xu, X.-J. Liu, and H.-S. Zong, PRD93 (2016) no. 3, 036006

F. Gao and Y.-x. Liu, PRD 94 (2016) no. 7, 076009

F. Gao and Y.-x. Liu, PRD 94 (2016) no. 9, 094030

- valuable for exploratory studies
- not good enough for quantitative and/or systematic studies

II. **treat Yang-Mills sector** explicitly

$N_f=2+1$ -QCD with DSEs

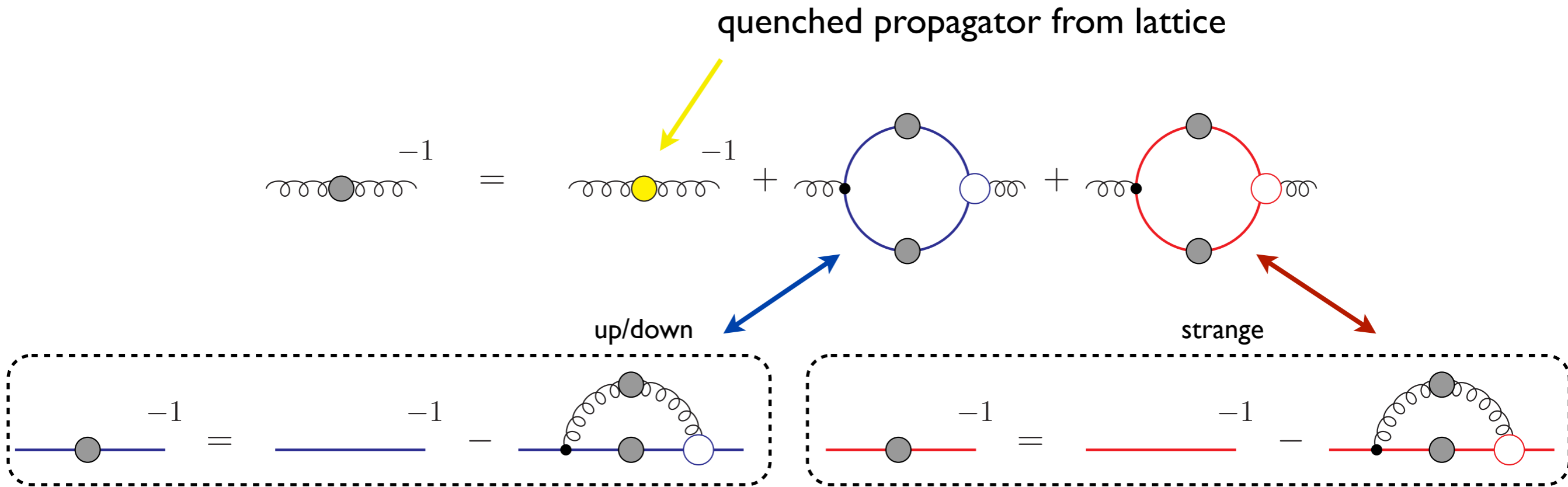

- quenched: without quark-loop
- $N_f=2$: isospin symmetry
- $N_f=2+1$: solve coupled system of $2+3+3$ equations
- Vertex: ansatz built along STI and known UV/IR behavior
→ T, μ, m -dependent

Approximation for Quark-Gluon interaction

- Lattice input for vertex: not yet available...
- Diagrammatics: vertex-DSE (see later...)

explicit solutions at T=0: Mitter, Pawłowski and Strodthoff, PRD 91 (2015) 054035
Williams, CF, Heupel, PRD PRD 93 (2016) 034026

→ talk of Pawłowski

- Slavnov-Taylor identity: T, μ, m-dependent vertex

$$\Gamma_\nu(q, k, p) = \tilde{Z}_3 \left(\delta_{4\nu} \gamma_4 \frac{C(k) + C(p)}{2} + \delta_{j\nu} \gamma_j \frac{A(k) + A(p)}{2} \right) \times$$
$$\times \left(\frac{d_1}{d_2 + q^2} + \frac{q^2}{\Lambda^2 + q^2} \left(\frac{\beta_0 \alpha(\mu) \ln[q^2 / \Lambda^2 + 1]}{4\pi} \right)^{2\delta} \right)$$

STI

PT

- d1 fixed via T_c
- d2 fixed to match scale of lattice gluon input

Glue at finite temperature ($T \neq 0$)

T-dependent gluon propagator from quenched lattice simulations:

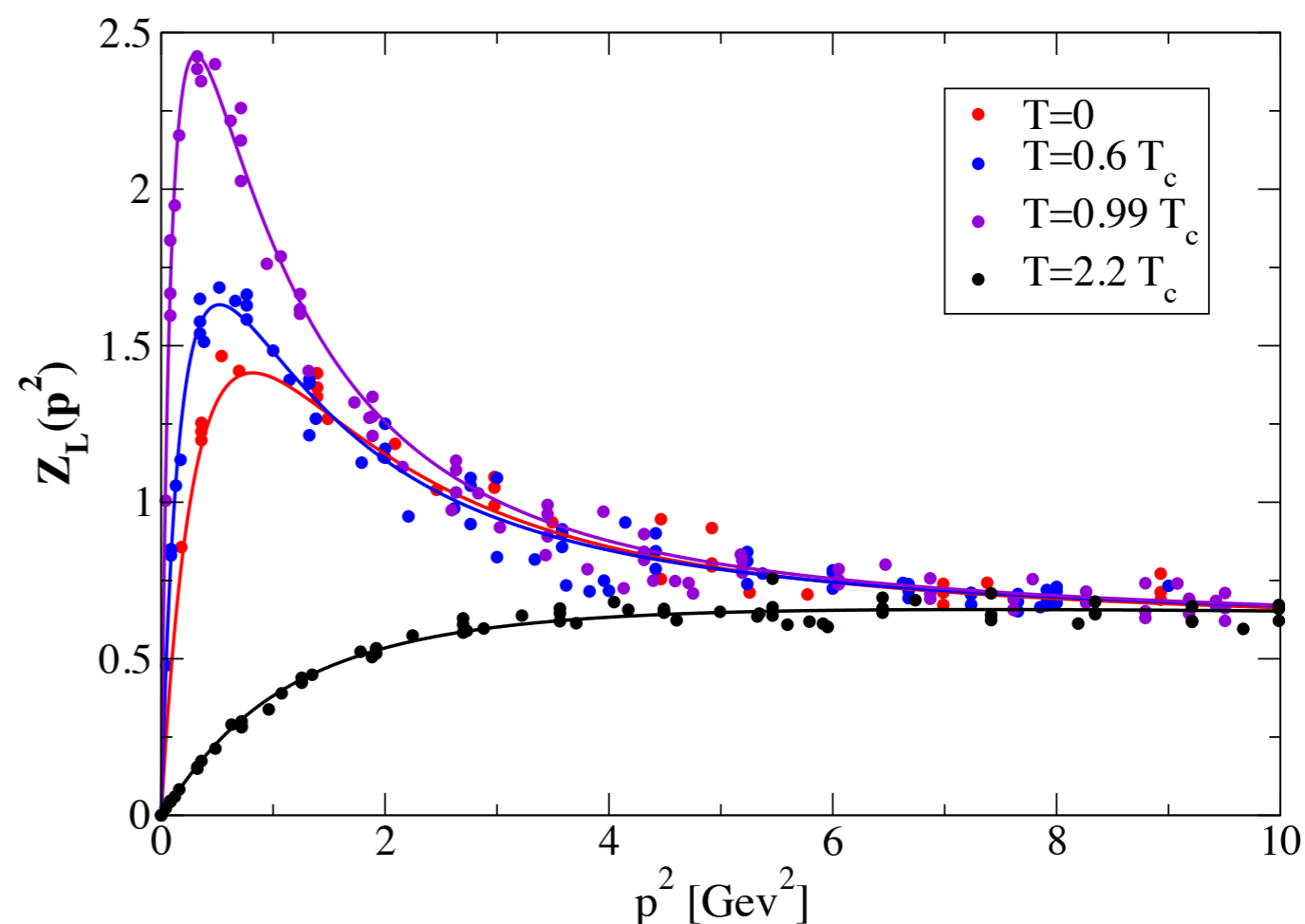
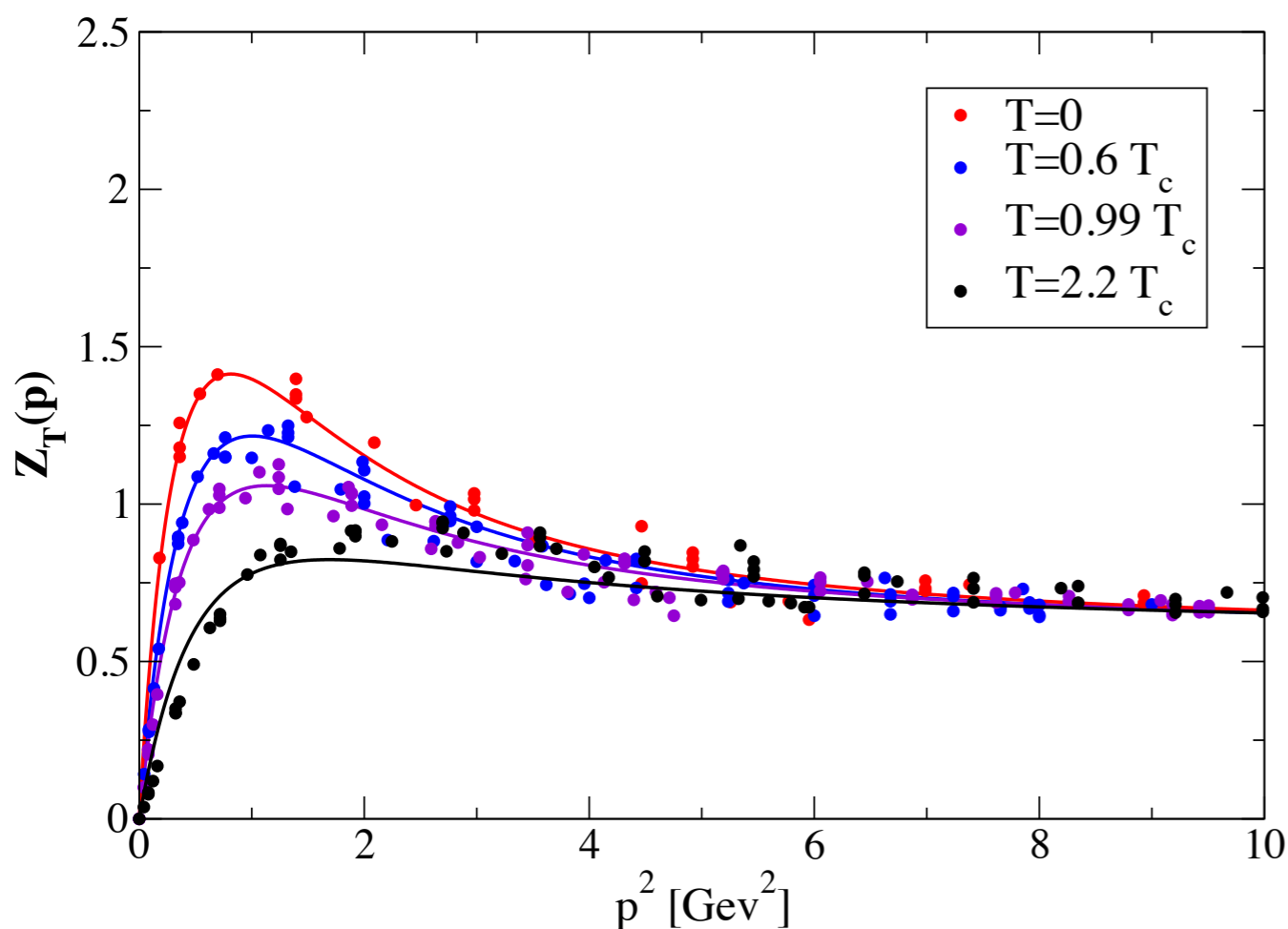

- Crucial difference between magnetic and electric gluon
- Maximum of electric gluon near T_c

Cucchieri, Maas, Mendes, PRD 75 (2007)

CF, Maas, Mueller, EPJC 68 (2010)

Cucchieri, Mendes, PoS FACESQCD 007 (2010)

Aouane, Bornyakov, Ilgenfritz, Mitrjushkin, Muller-Preussker and Sternbeck, PRD 85 (2012) 034501

Silva, Oliveira, Bicudo, Cardoso, PRD 89 (2014) 074503

FRG: Fister, Pawlowski, arXiv:1112.5440

Critical line/surface for heavy quarks

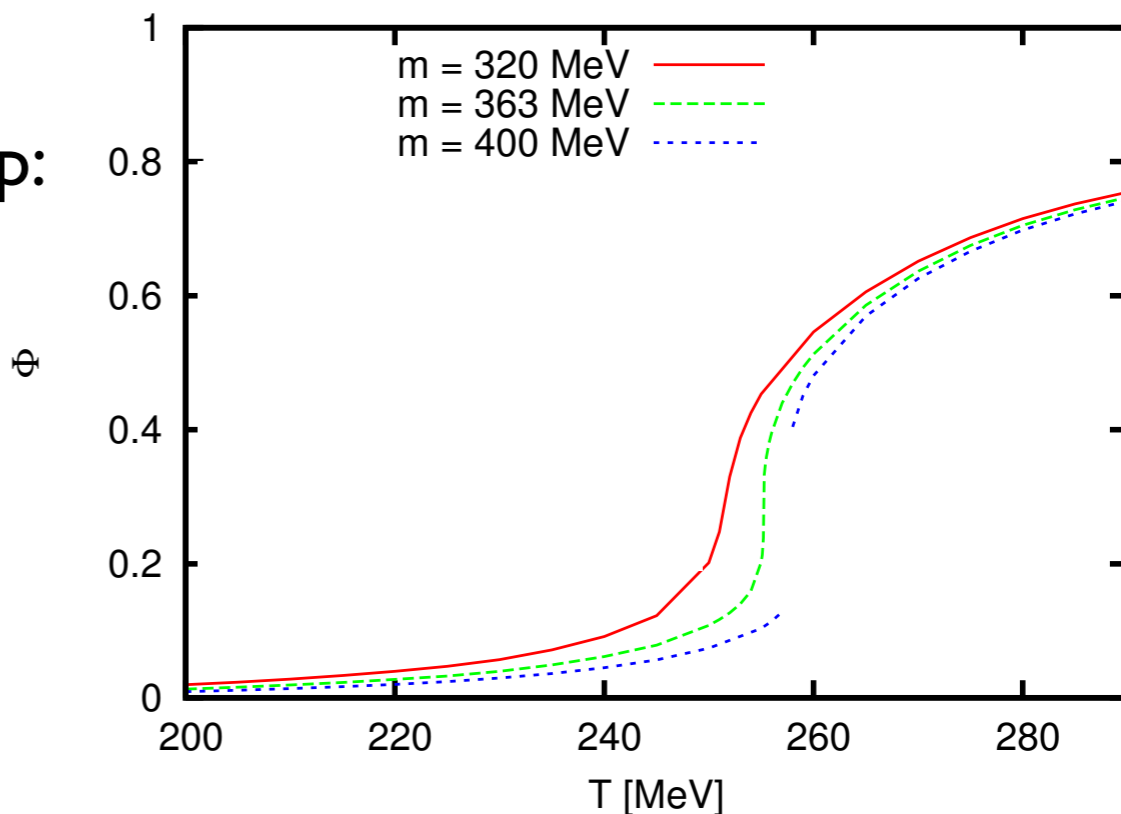
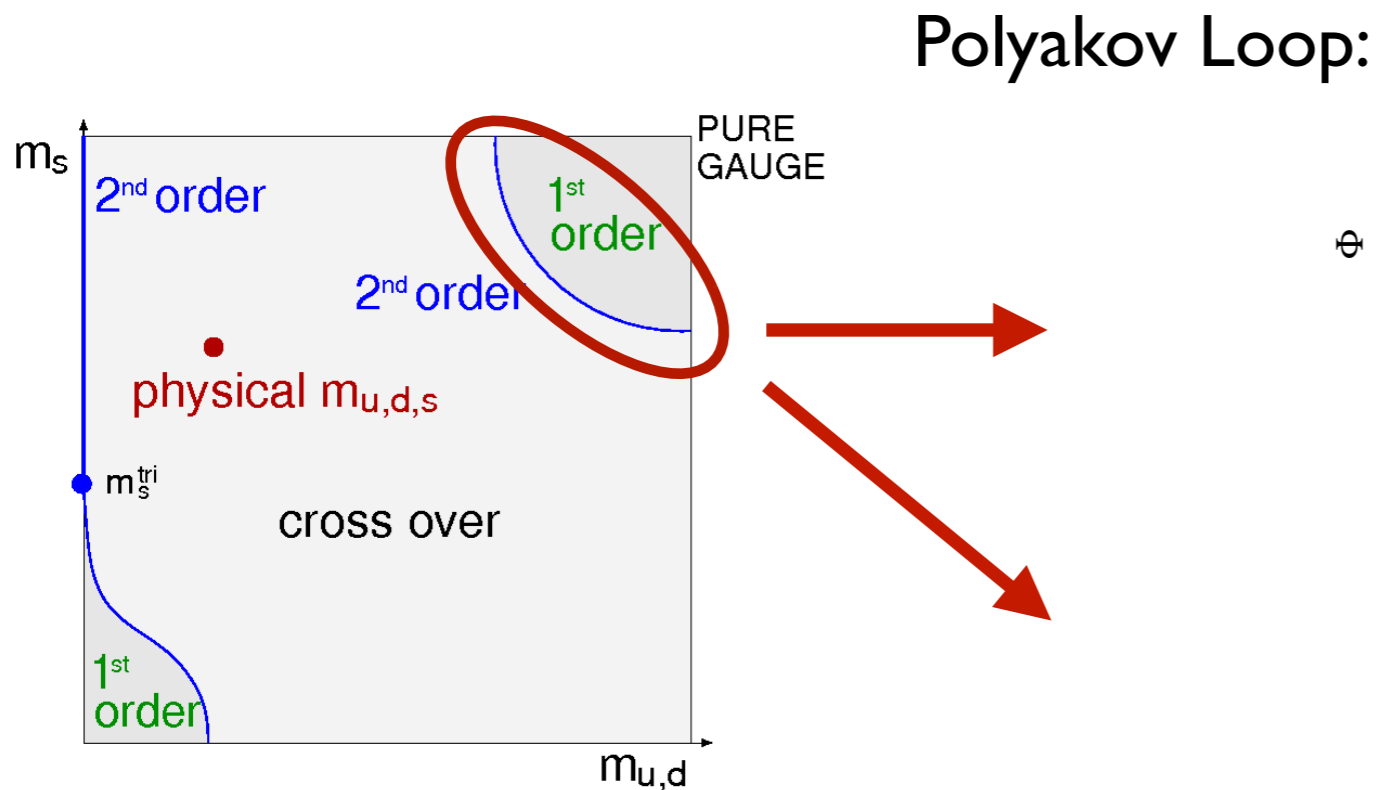

- Deconfinement transition in agreement with lattice QCD
- Correct tricritical scaling
- Roberge-Weiss-transition seen

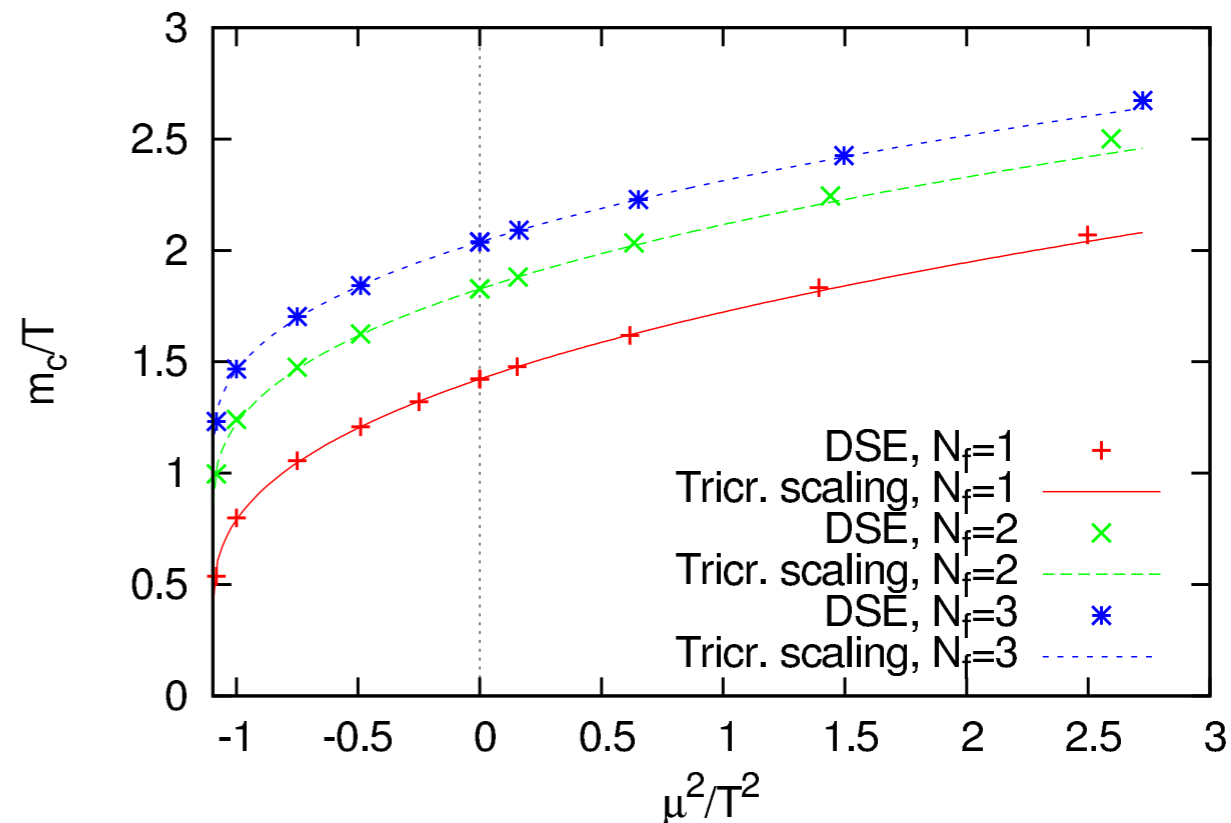

Lattice:

Fromm, Langelage, Lottini, Philipsen, JHEP 1201 (2012) 042

CF, Luecker, Pawlowski, PRD 91 (2015) 1

Critical line/surface for heavy quarks

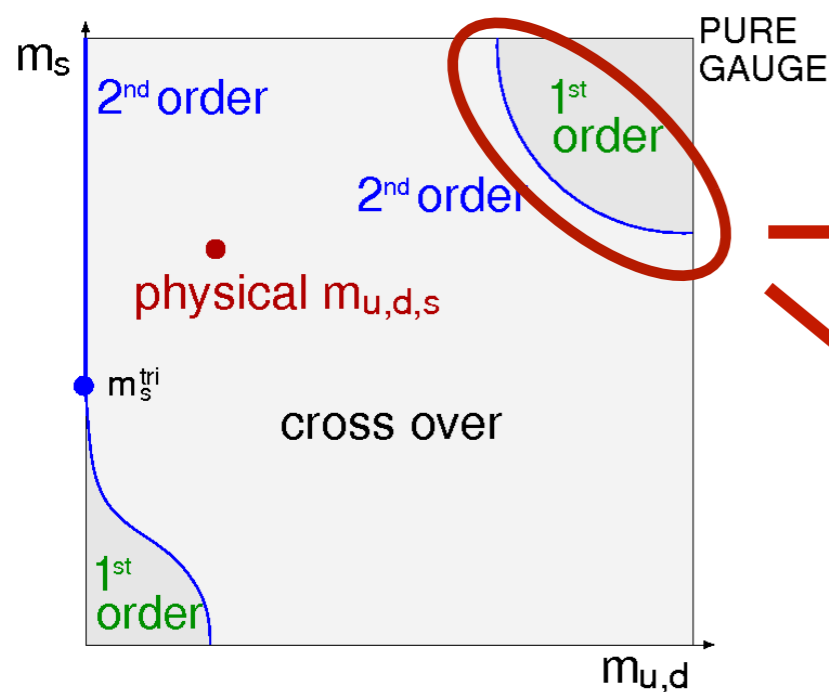

Polyakov Loop:

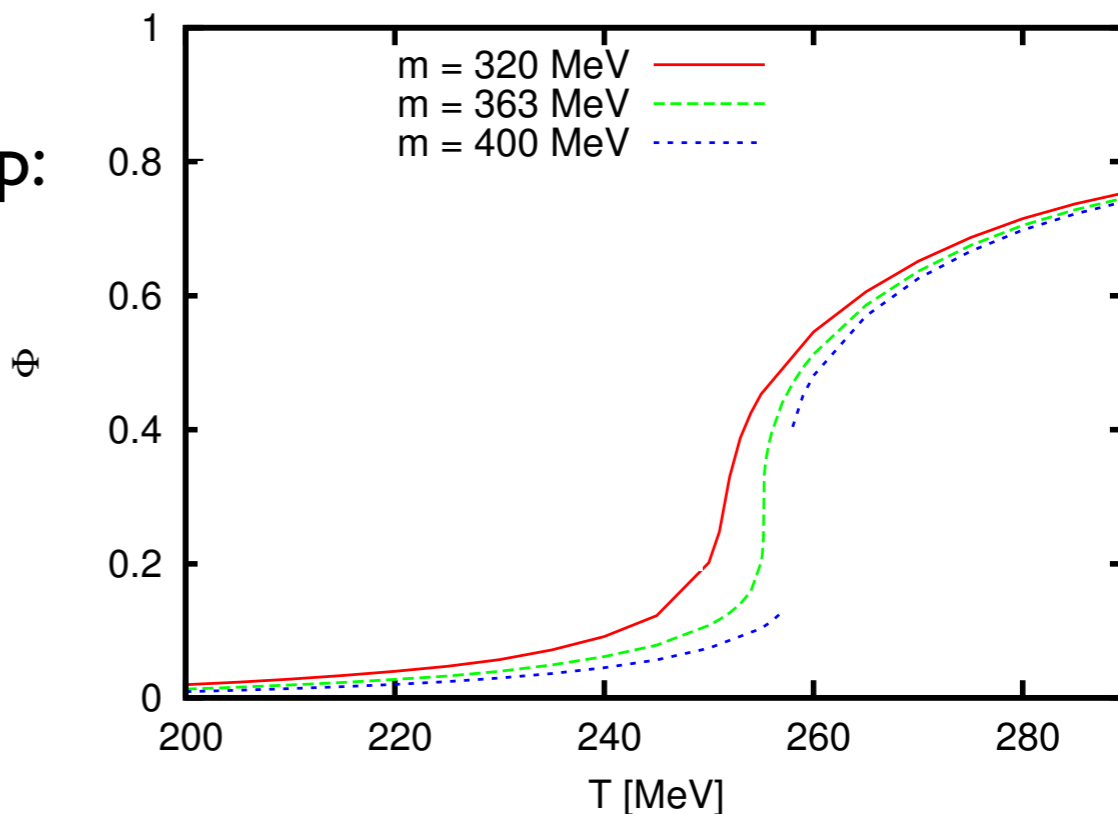

- Deconfinement transition in agreement with lattice QCD
- Correct tricritical scaling
- Roberge-Weiss-transition seen

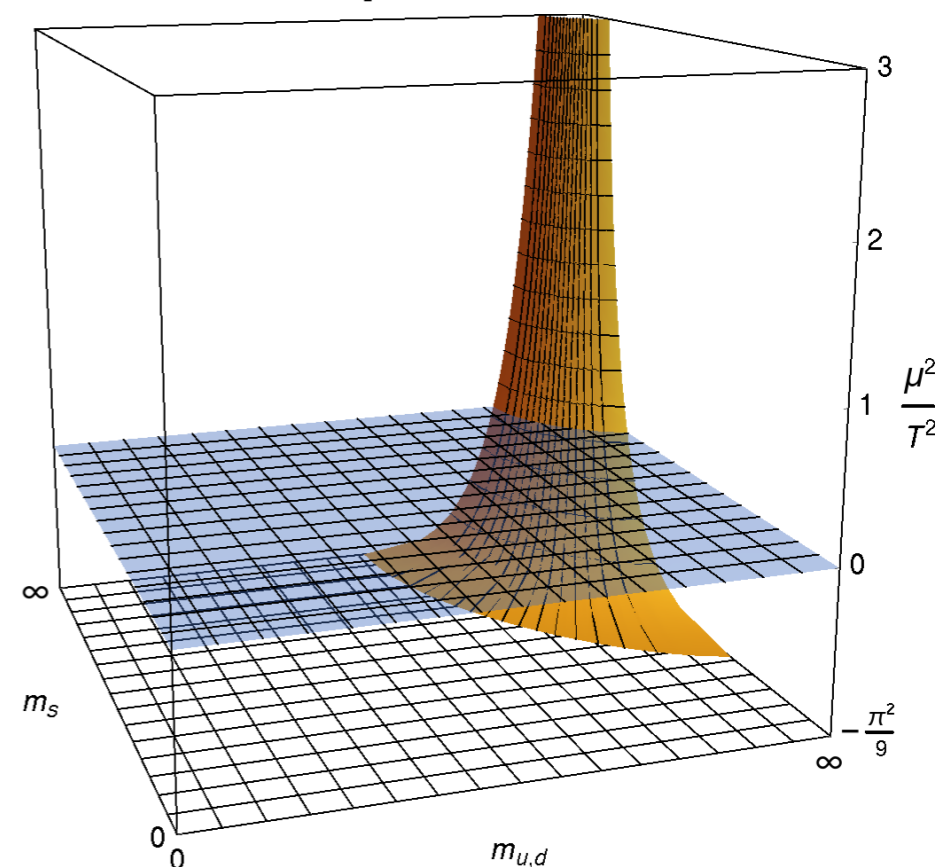

CF, Luecker, Pawłowski, PRD 91 (2015) 1

Lattice:
Fromm, Langelage, Lottini, Philipsen, JHEP 1201 (2012) 042

Critical line/surface for heavy quarks

Nf=2: CF and Mueller, PRD 84 (2011) 054013

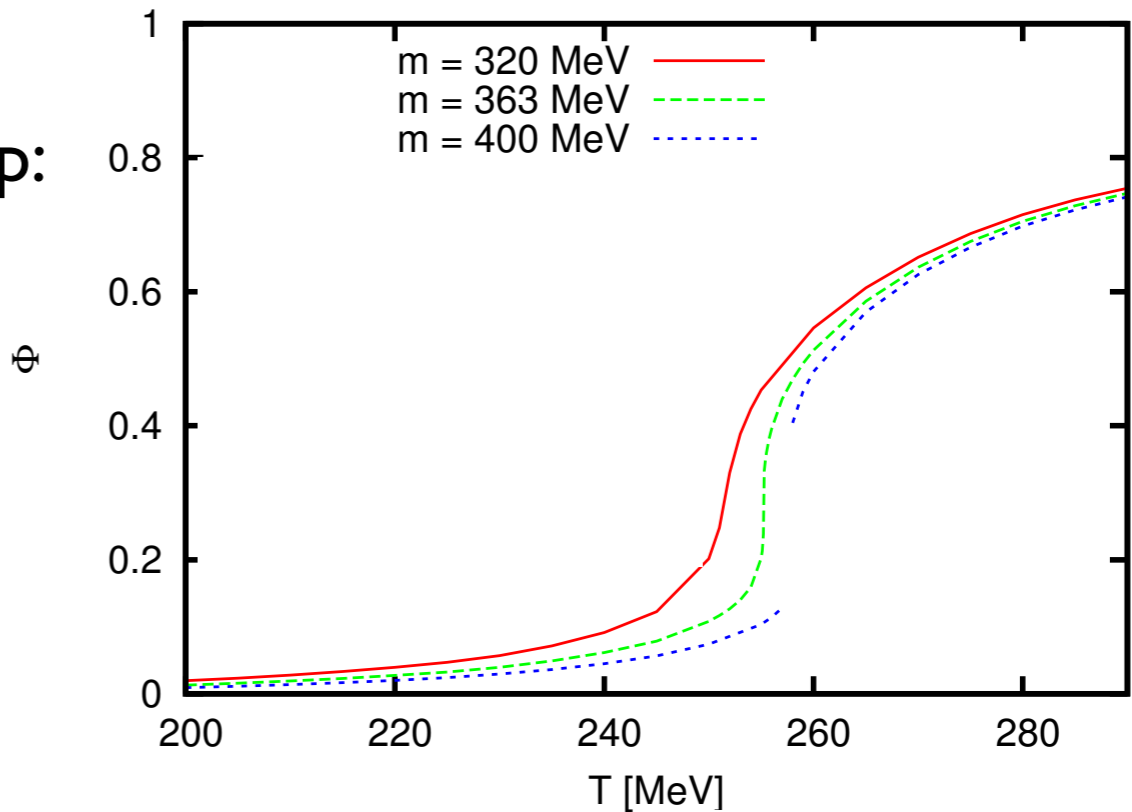
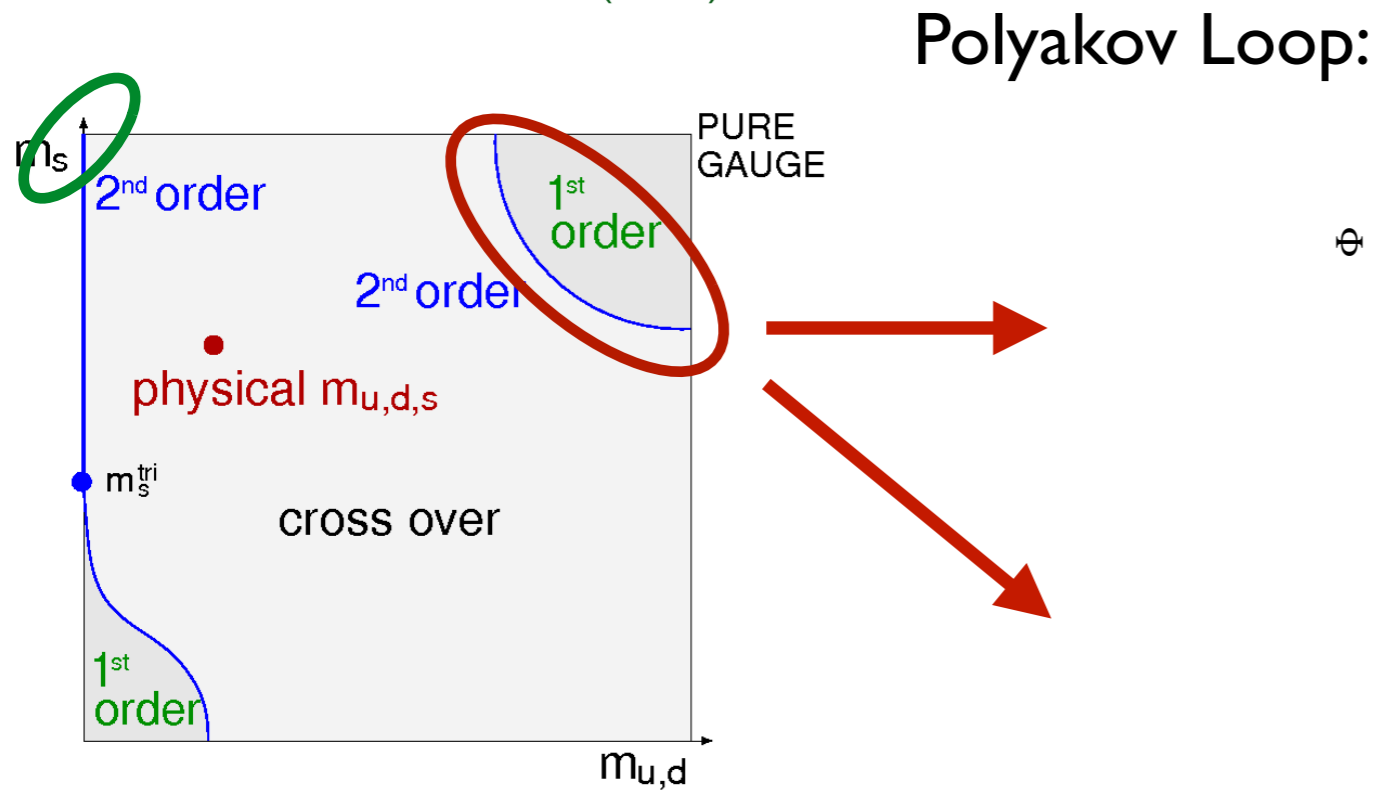

- Deconfinement transition in agreement with lattice QCD
- Correct tricritical scaling
- Roberge-Weiss-transition seen

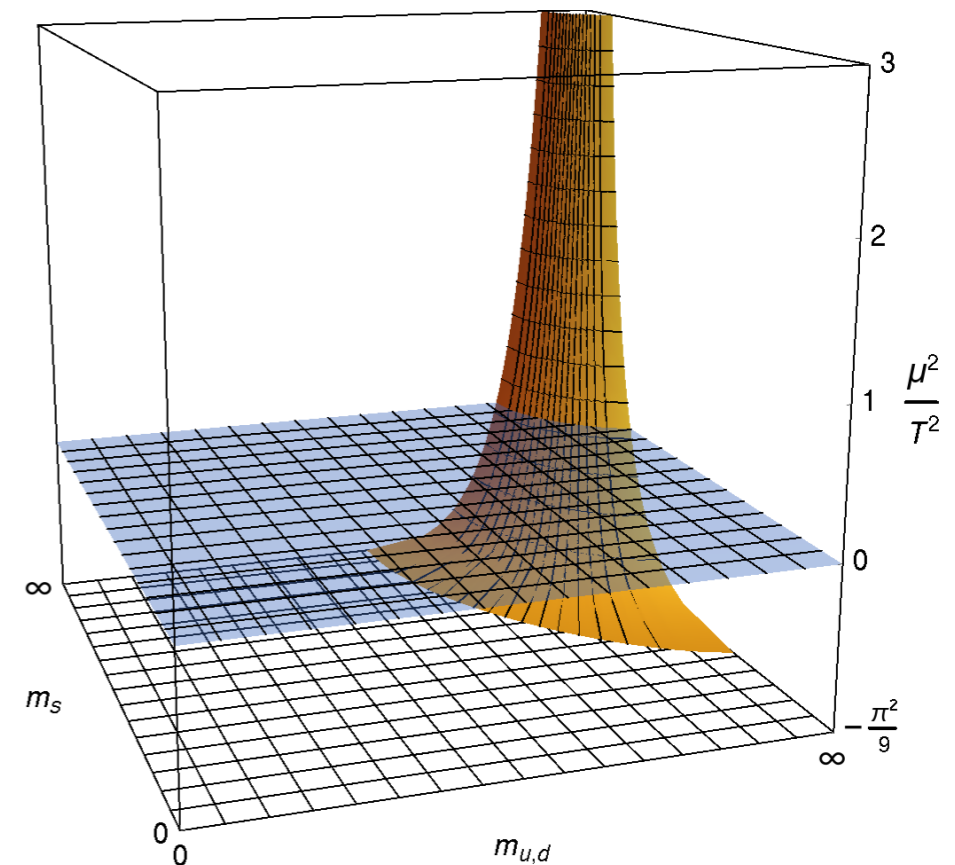

CF, Luecker, Pawlowski, PRD 91 (2015) 1

Lattice:

Fromm, Langelage, Lottini, Philipsen, JHEP 1201 (2012) 042

$N_f=2+1, \mu=0$, physical point

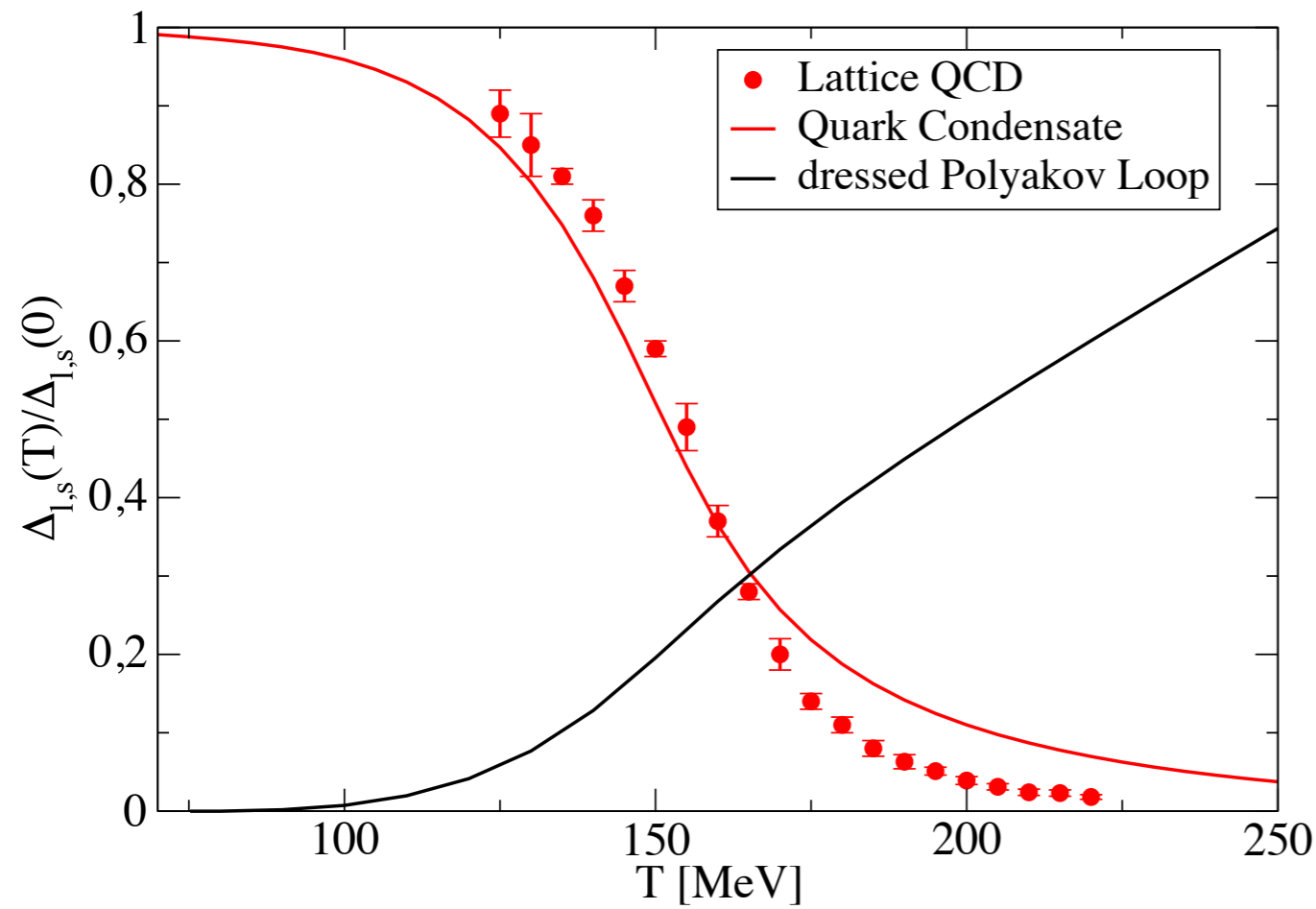
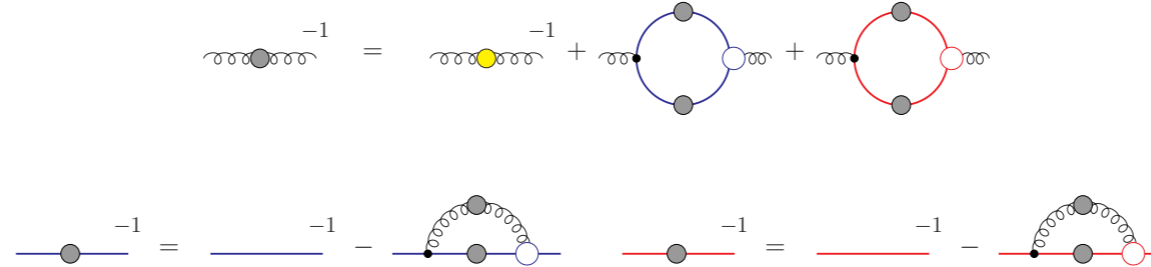
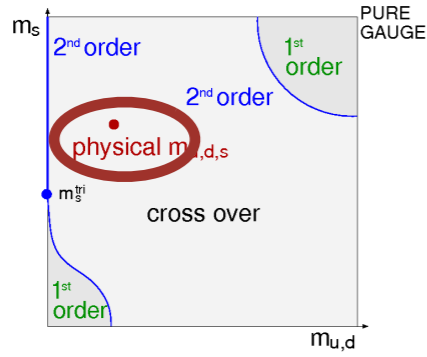

Lattice: Borsanyi *et al.* [Wuppertal-Budapest], JHEP 1009(2010) 073

DSE: CF, Luecker, PLB 718 (2013) 1036,
CF, Luecker, Welzbacher, PRD 90 (2014) 034022

$N_f=2+1, \mu=0$, physical point

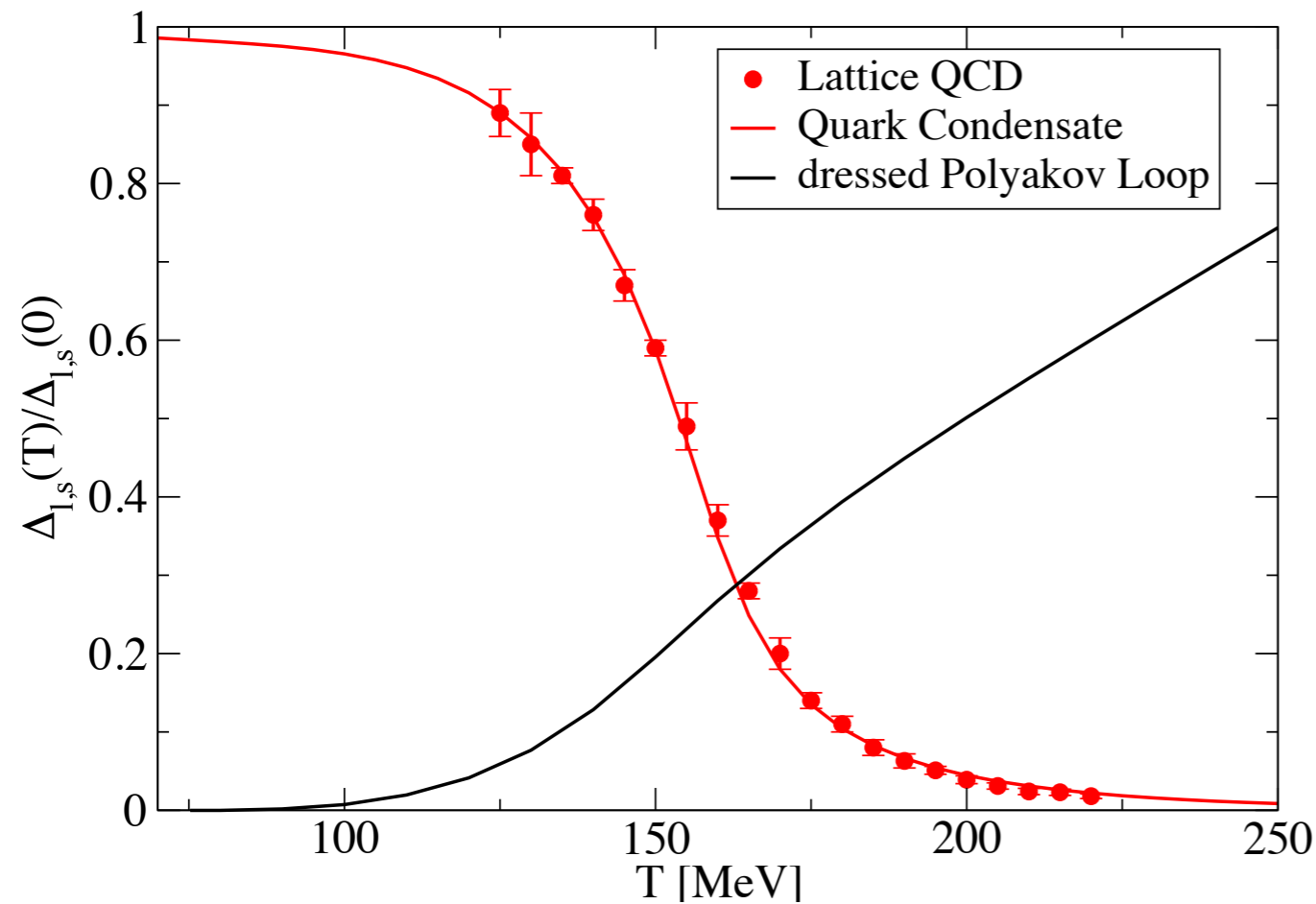
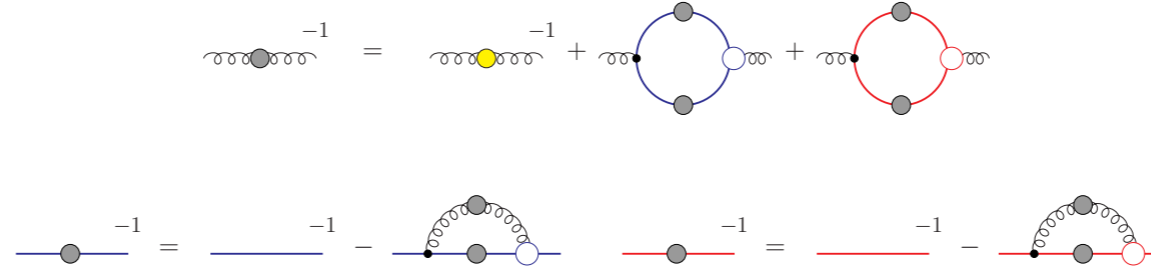
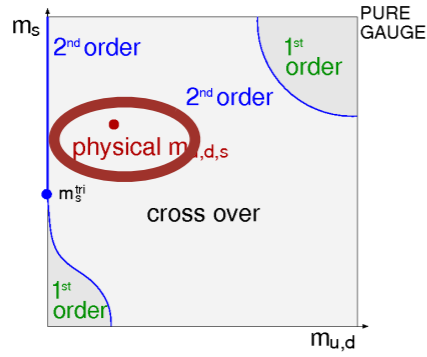

Lattice: Borsanyi *et al.* [Wuppertal-Budapest], JHEP 1009(2010) 073

DSE: CF, Luecker, PLB 718 (2013) 1036,
CF, Luecker, Welzbacher, PRD 90 (2014) 034022

$N_f=2+1, \mu=0$, physical point

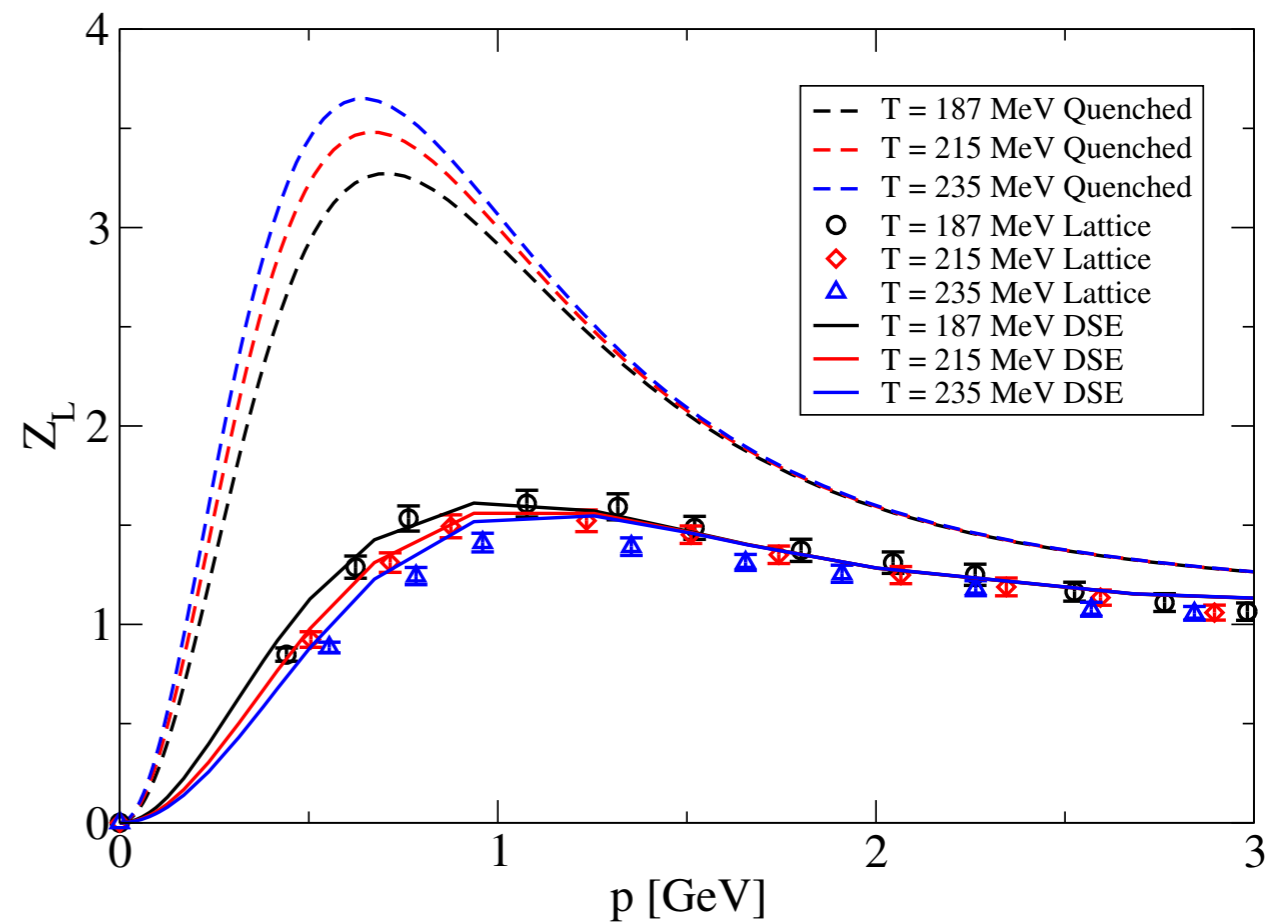
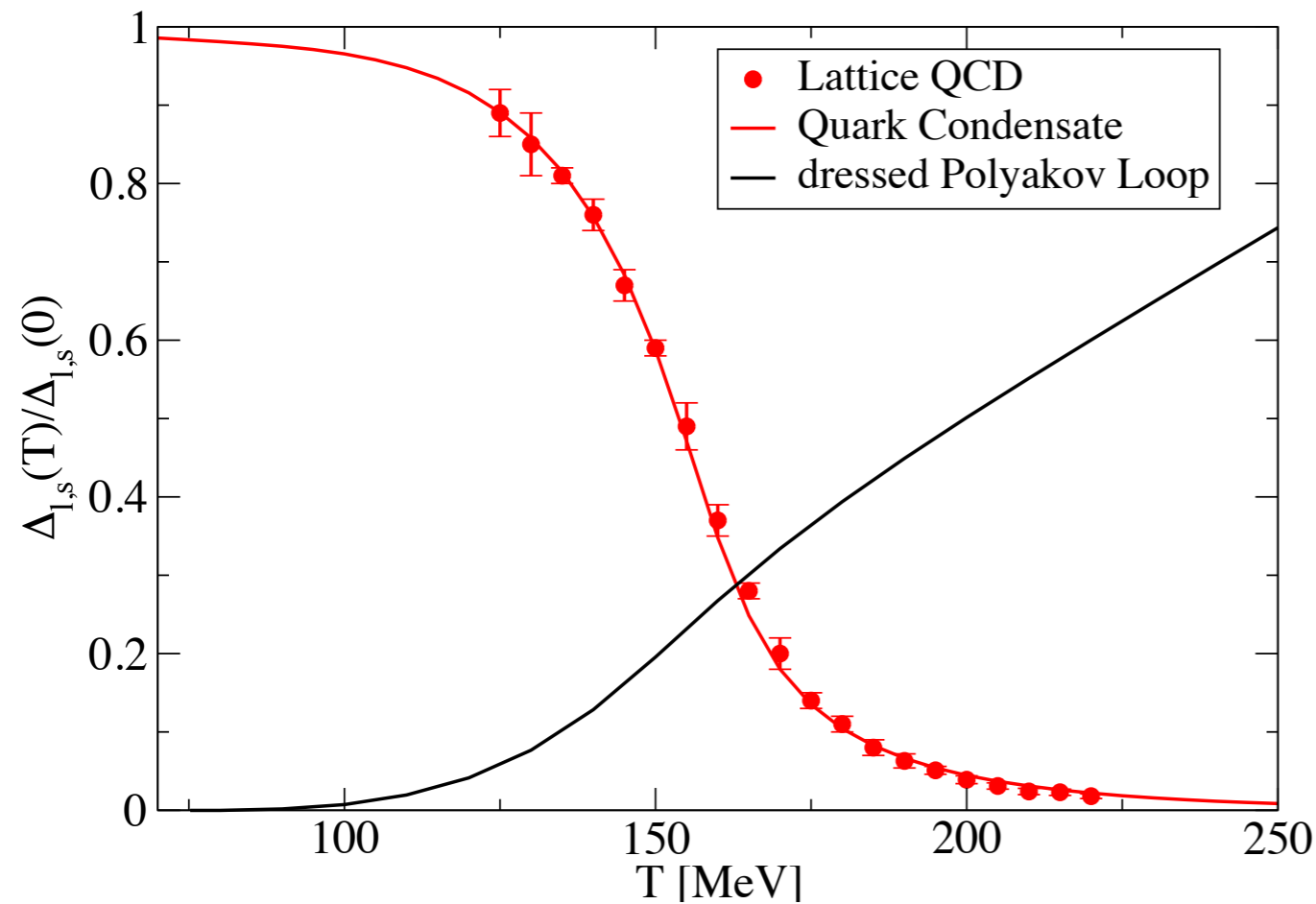
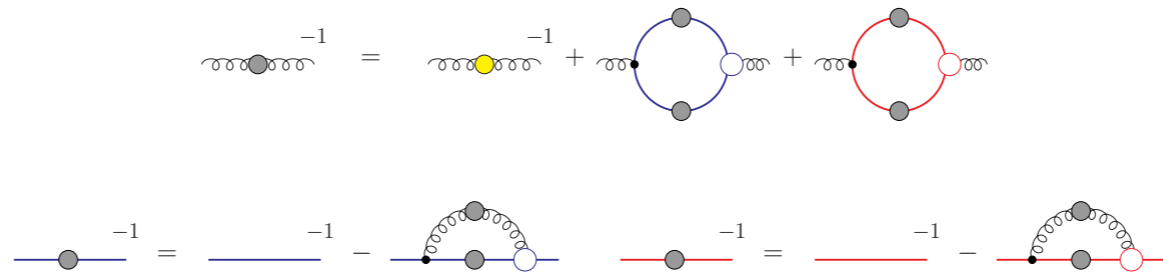
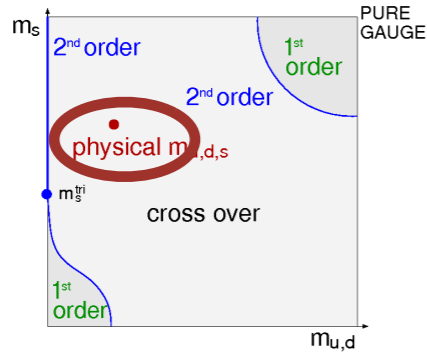

Lattice: Borsanyi *et al.* [Wuppertal-Budapest], JHEP 1009(2010) 073
 DSE: CF, Luecker, PLB 718 (2013) 1036,
 CF, Luecker, Welzbacher, PRD 90 (2014) 034022

Lattice: Aouane, *et al.* PRD D87 (2013), [arXiv:1212.1102]
 DSE: CF, Luecker, PLB 718 (2013) 1036, [arXiv:1206.5191]

● quantitative agreement: DSE prediction verified by lattice

$N_f=2+1$: Condensate and dressed Polyakov Loop

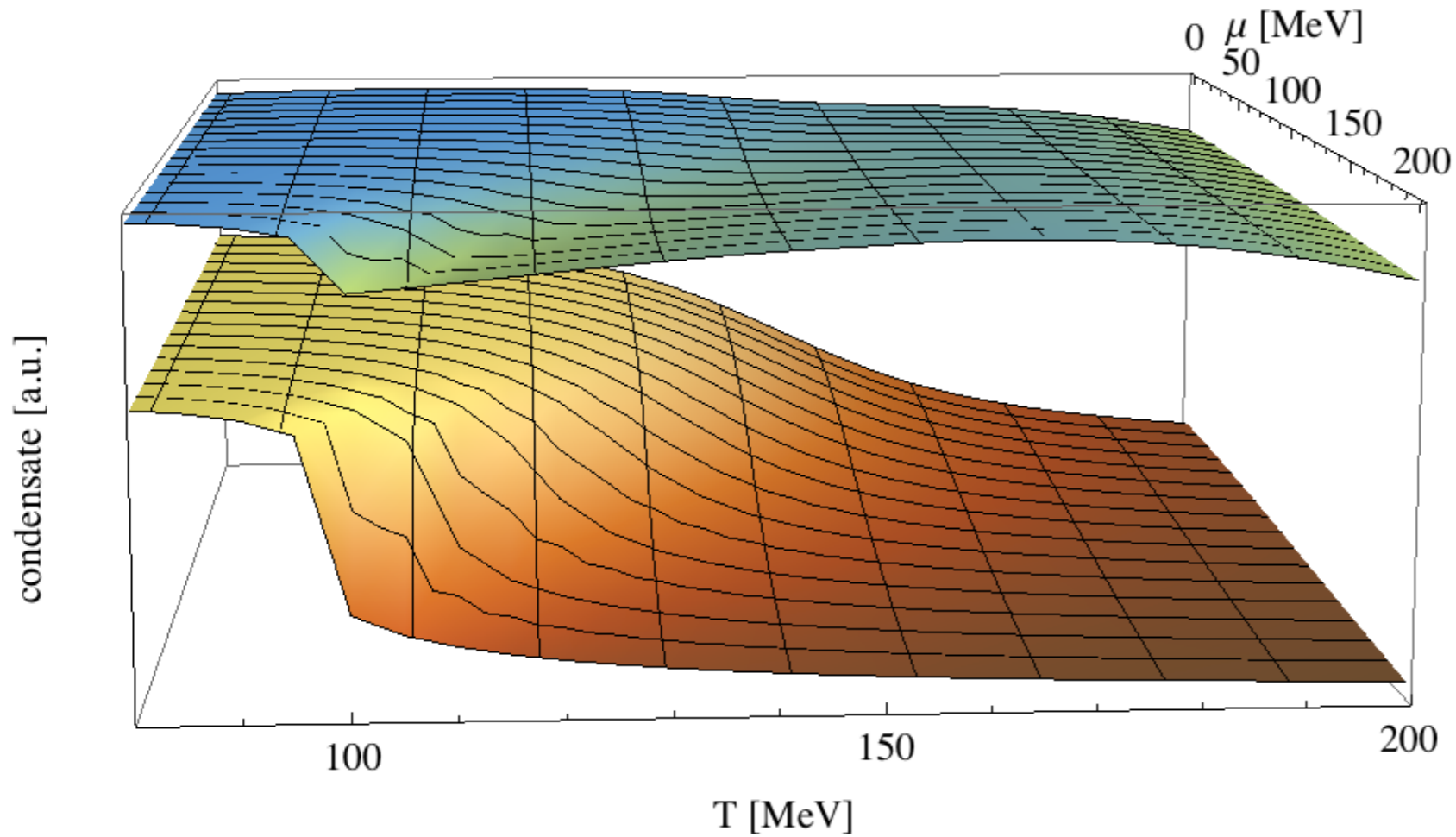

Quark condensate

Polyakov-Loop

$$L = \frac{1}{N_c} \text{tr} e^{ig \int A_0}$$

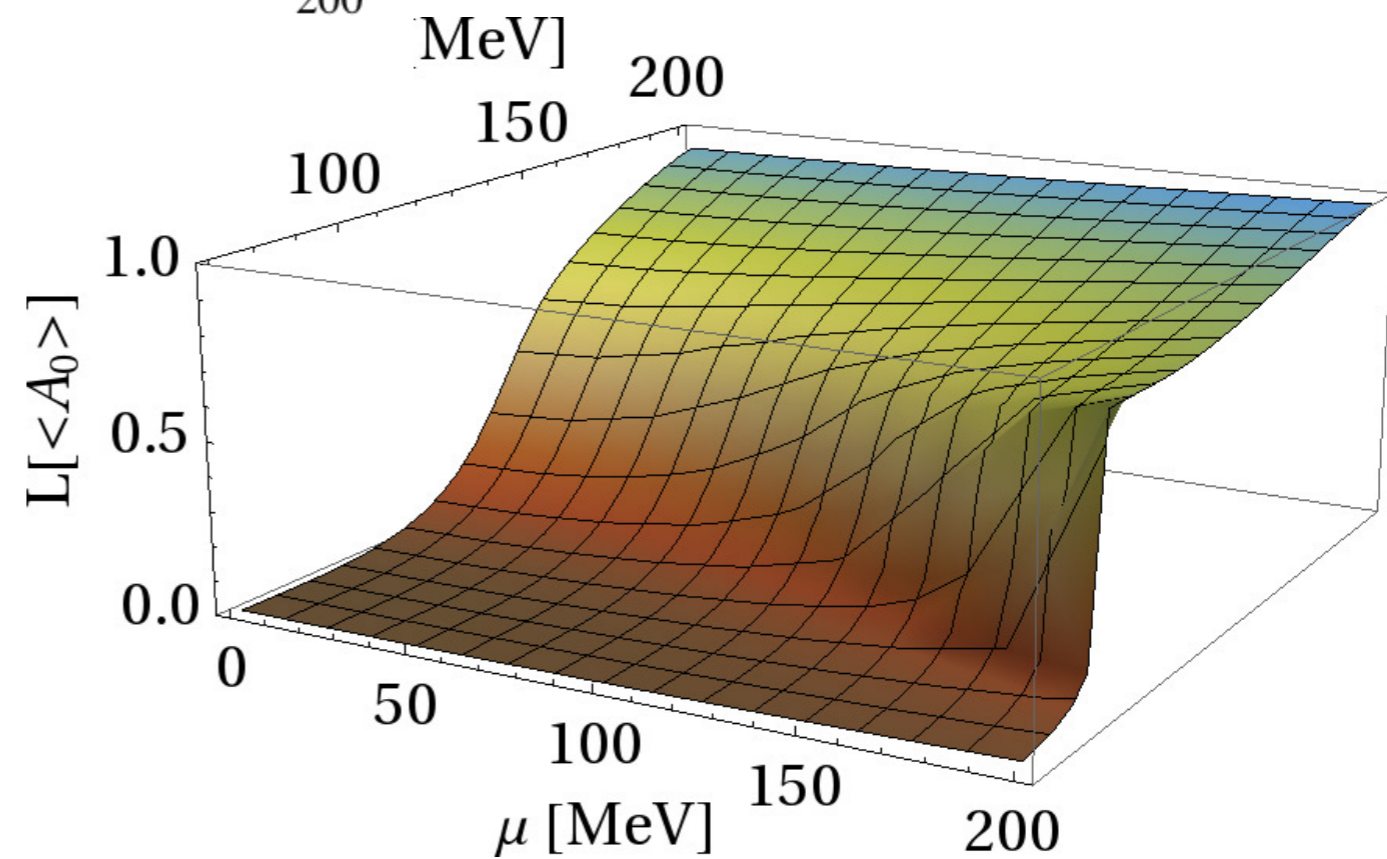

CF, Fister, Luecker, Pawłowski, PLB 732 (2014) 273

$N_f=2+1$: phase diagram

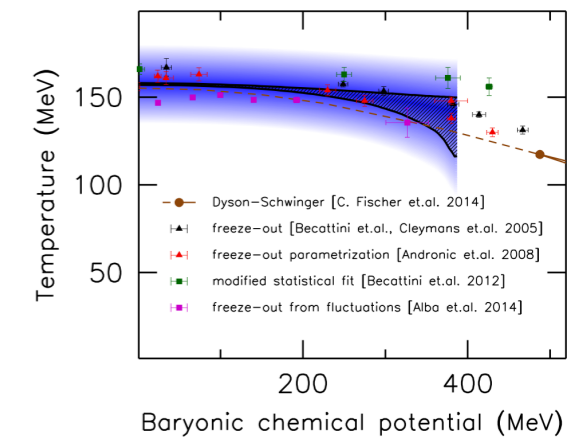
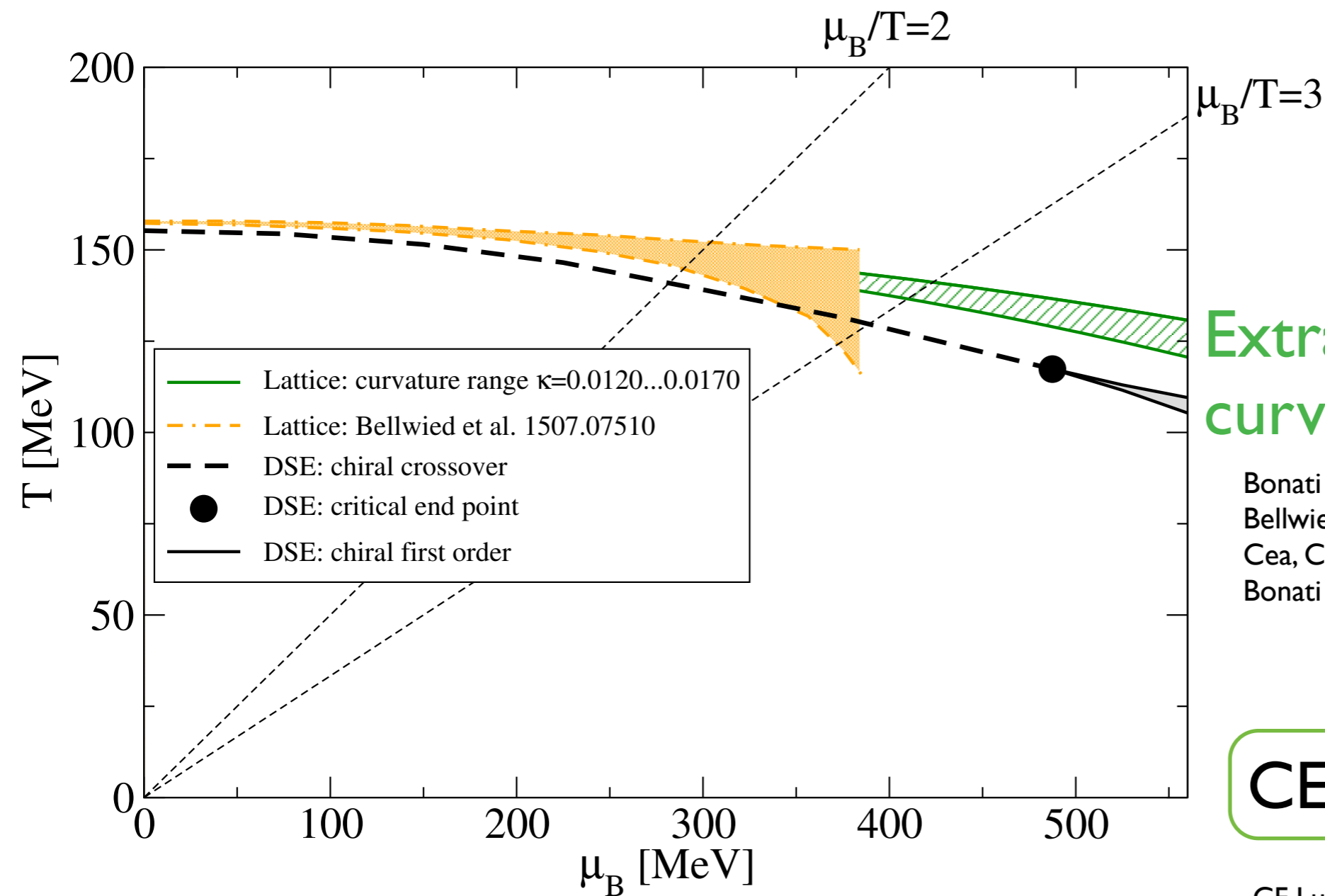

Extrapolated curvature from lattice

Bonati et al., PRD 92 (2015) 054503
 Bellwied et al. PLB 751 (2015) 559
 Cea, Cosmai, Papa, PRD 89 (2014), PRD 93 (2016)
 Bonati et al., arXiv:1805.02960

CEP at large μ

CF, Luecker, PLB 718 (2013) 1036,
 CF, Fister, Luecker, Pawlowski, PLB 732 (2014) 273
 CF, Luecker, Welzbacher, PRD 90 (2014) 034022

● combined evidence of FRG and DSE: no CEP at $\mu_B/T < 2$

$N_f=2+1+1$: effects of charm

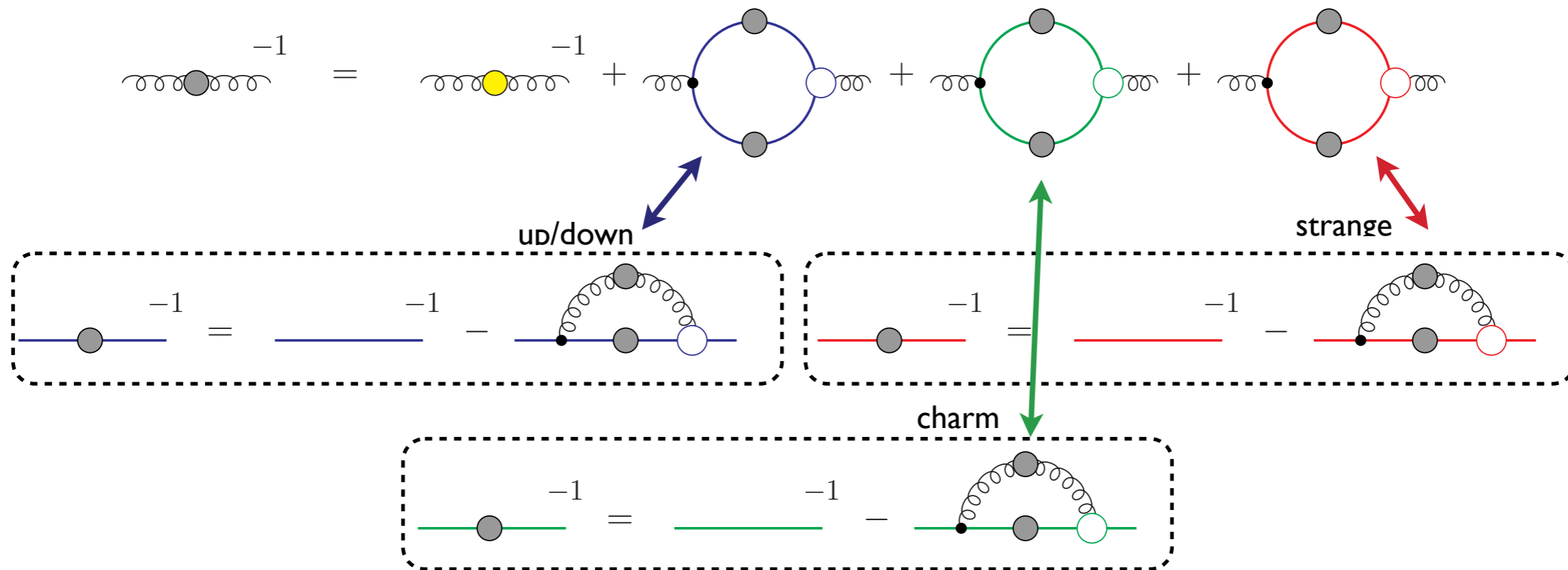

- Physical up/down, strange and **charm quark masses**
- Transition controlled by chiral dynamics
- *no lattice or model results available yet*

$N_f=2+1+1$: effects of charm

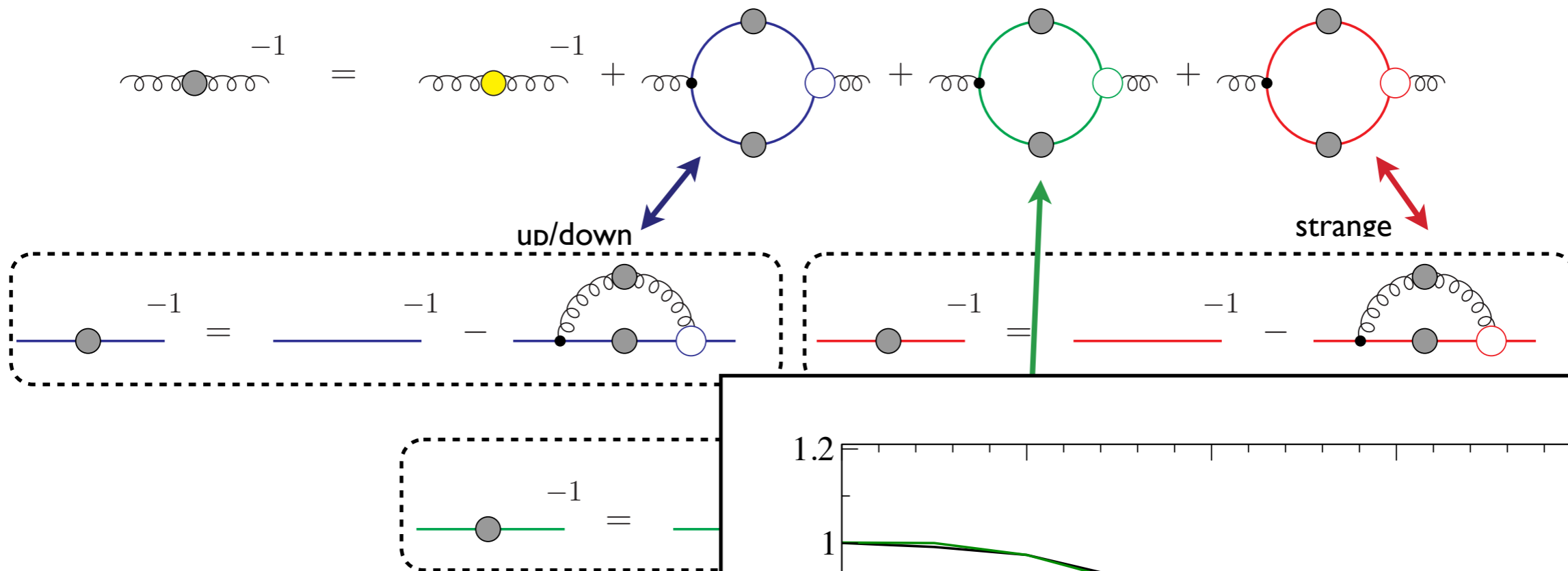

- Physical up/down, strange and **charm quark masses**
- Transition controlled by chiral dynamics
- *no lattice or model results available yet*

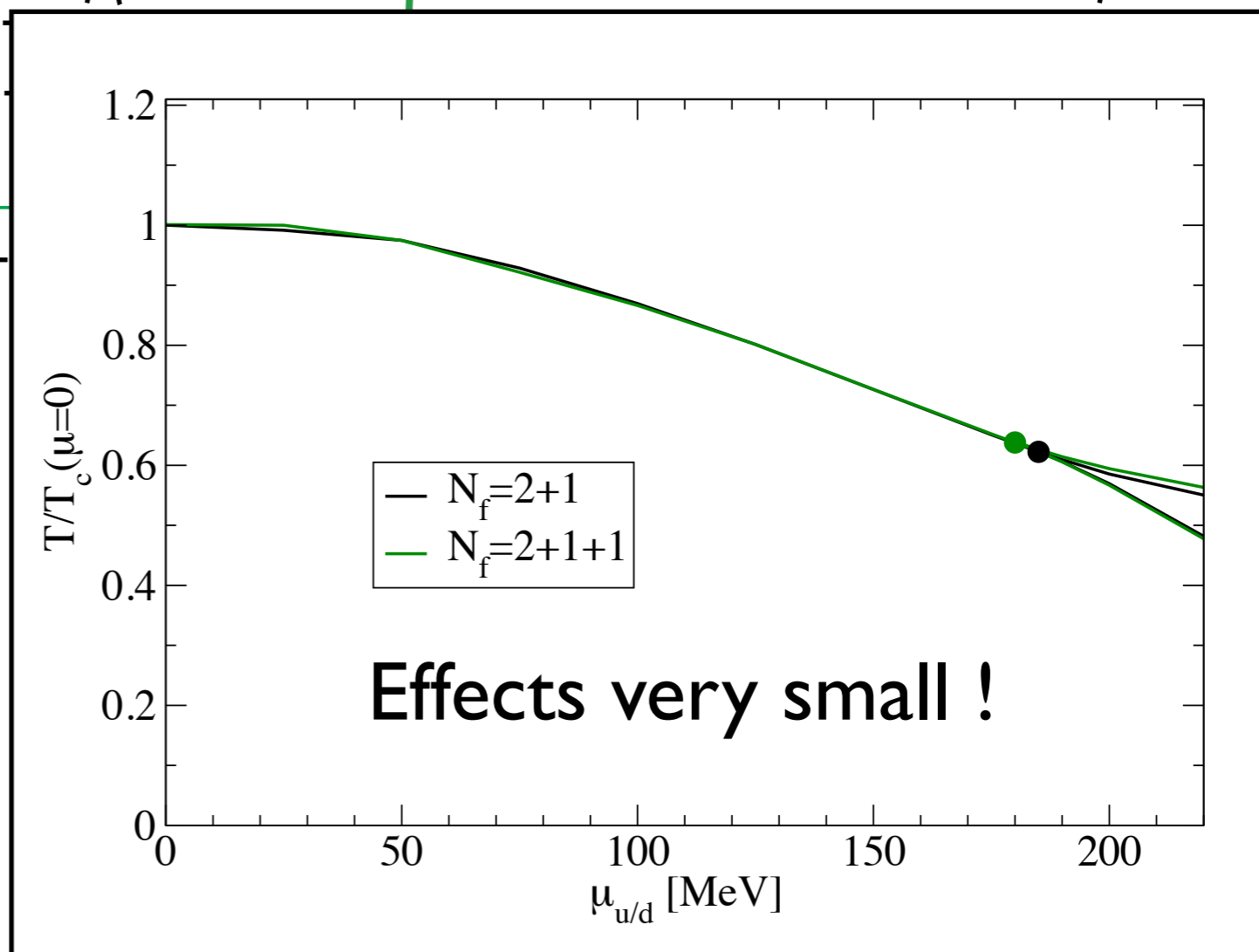

CF, Luecker, Welzbacher, PRD 90 (2014) 034022

Location of CEP in freeze-out landscape

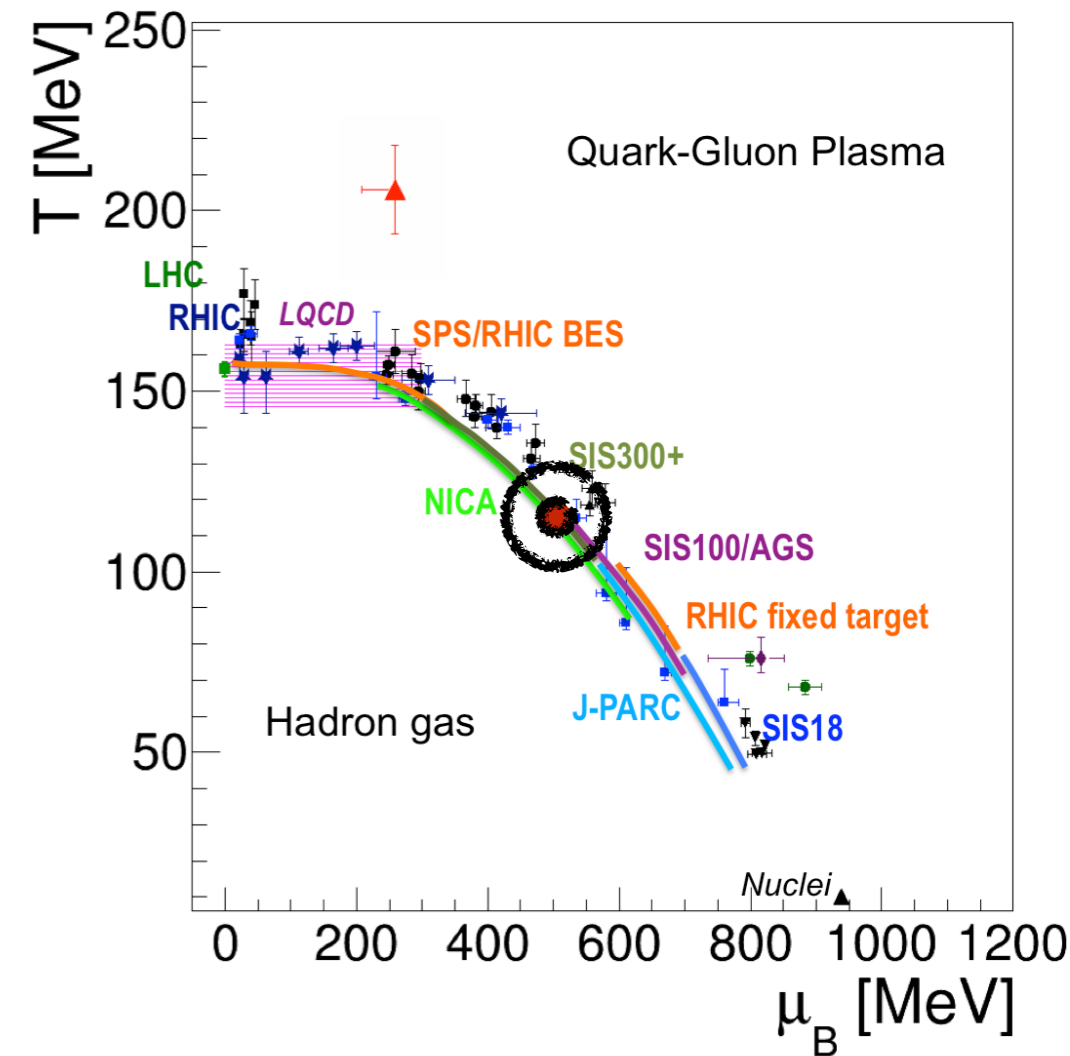
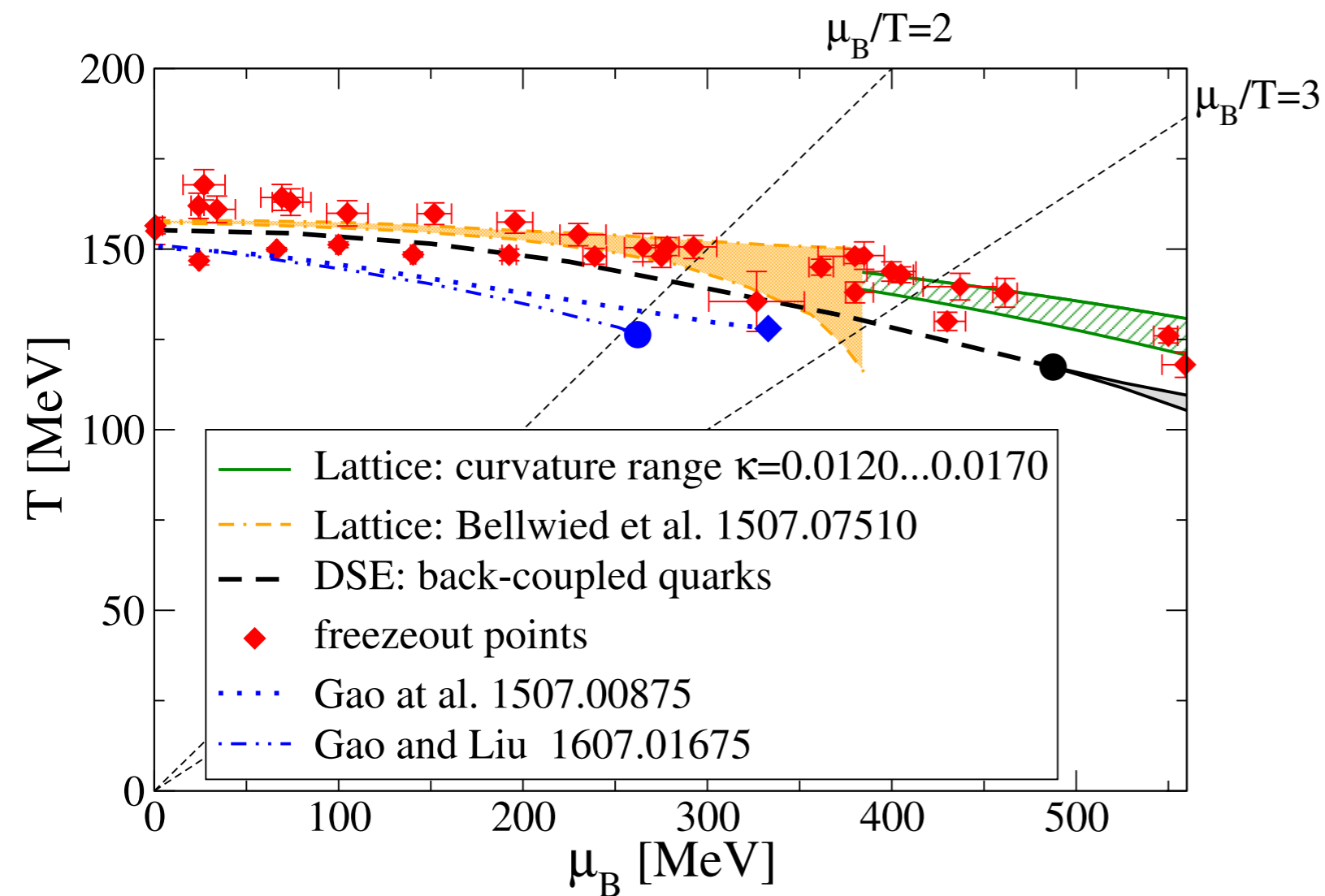

Figure adapted from talk of T. Galatyuk, Erice 2016

Caveats:

- inhomogeneous phases
- effects of baryons ?
- ...

Müller, Buballa and Wambach, PLB 727 (2013) 240

$N_c=2$: Brauner, Fukushima and Hidaka, PRD 80 (2009) 74035
Strodthoff, Schaefer and Smekal, PRD 85 (2012) 074007

1. Introduction

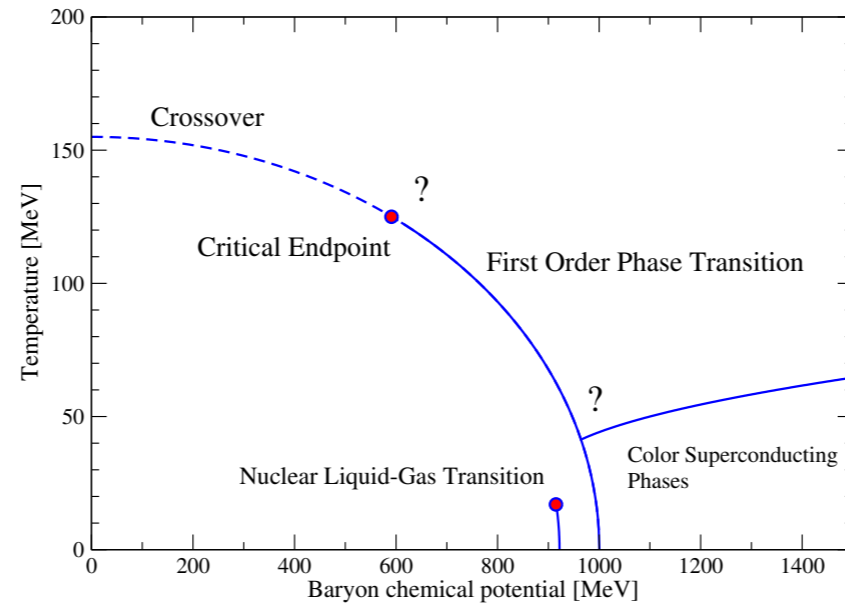

2. Gluons, quarks and the CEP

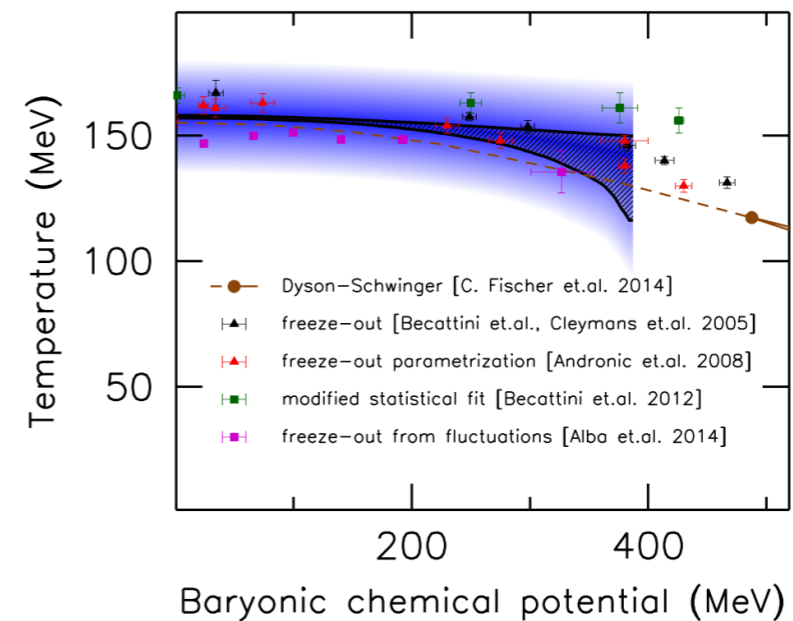

3. Hadron effects

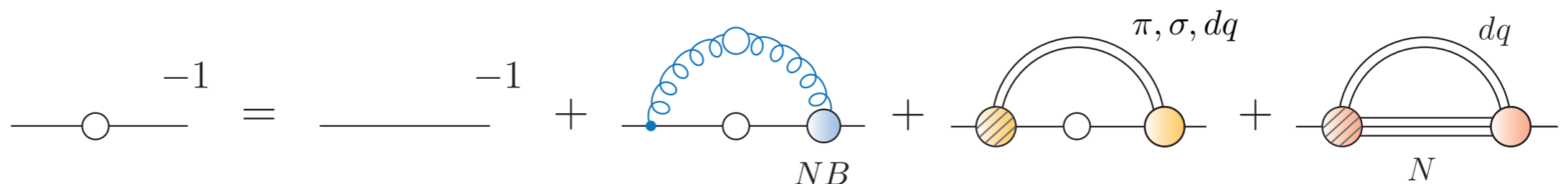

Hadron effects in the QCD phase diagram

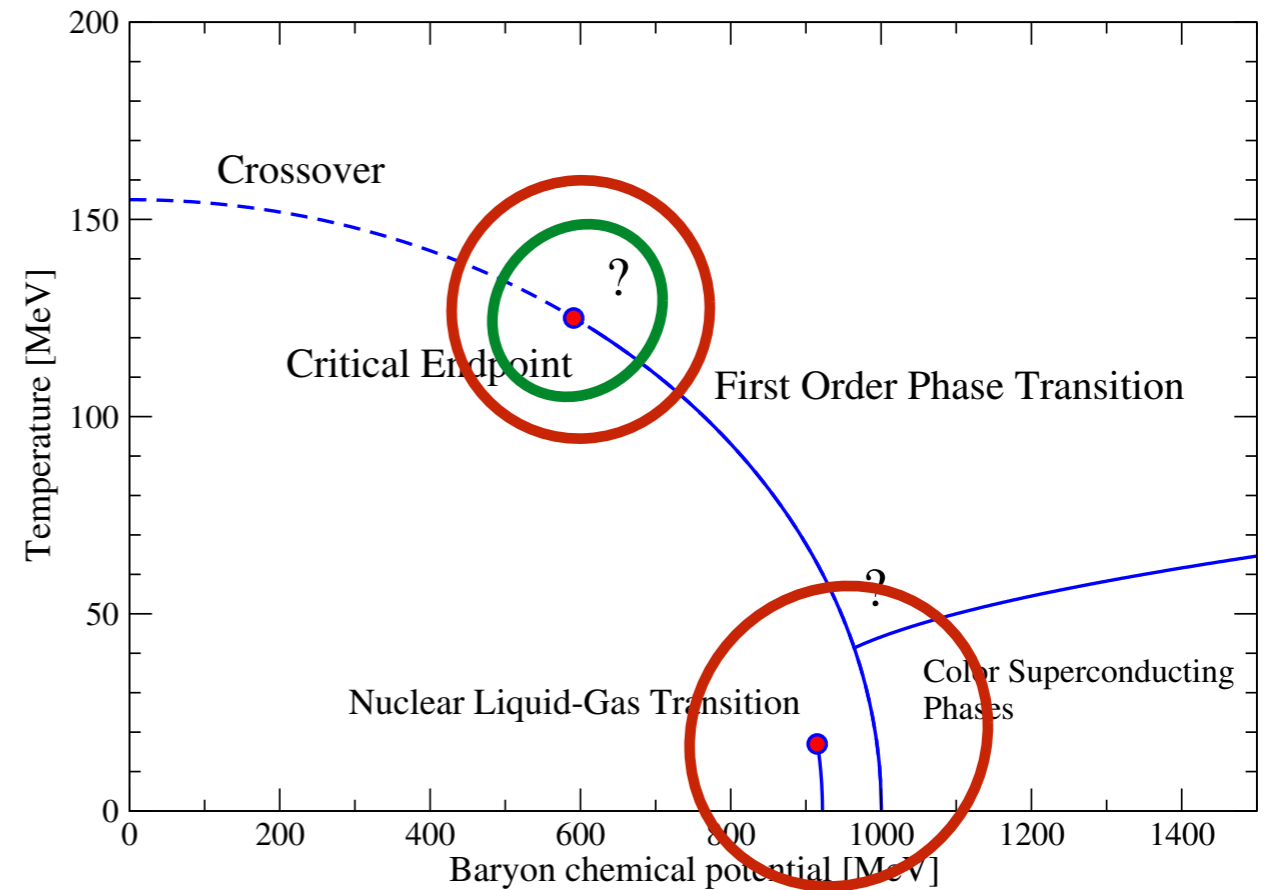
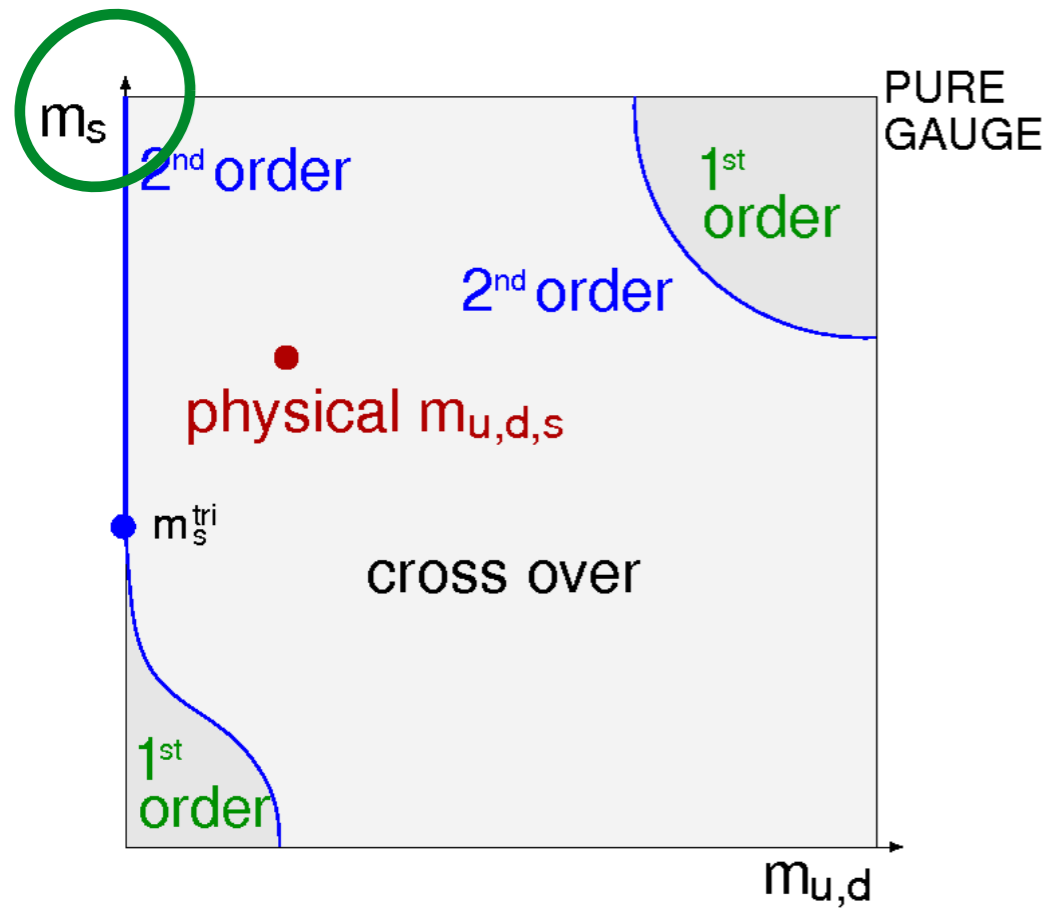

- Meson effects: critical chiral physics, ...
- Baryon effects

Chiral mirror model: Weyrich, Strodthoff and von Smekal, PRC 92 (2015) no.1, 015214

→ truncation of DSEs good enough to include these effects ?

Hadron effects in quark-gluon interaction

quark-gluon vertex:

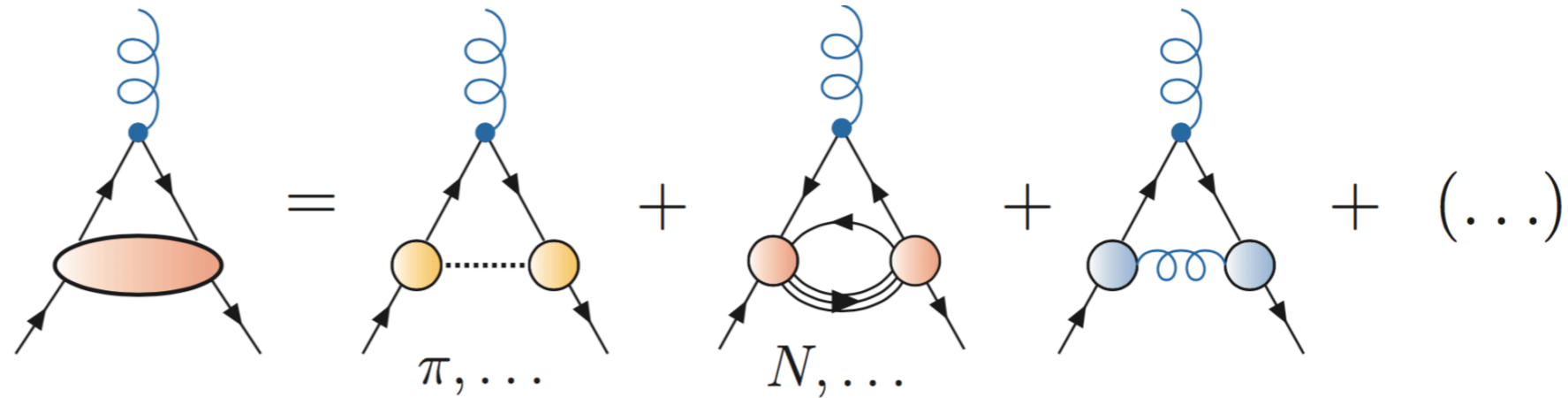
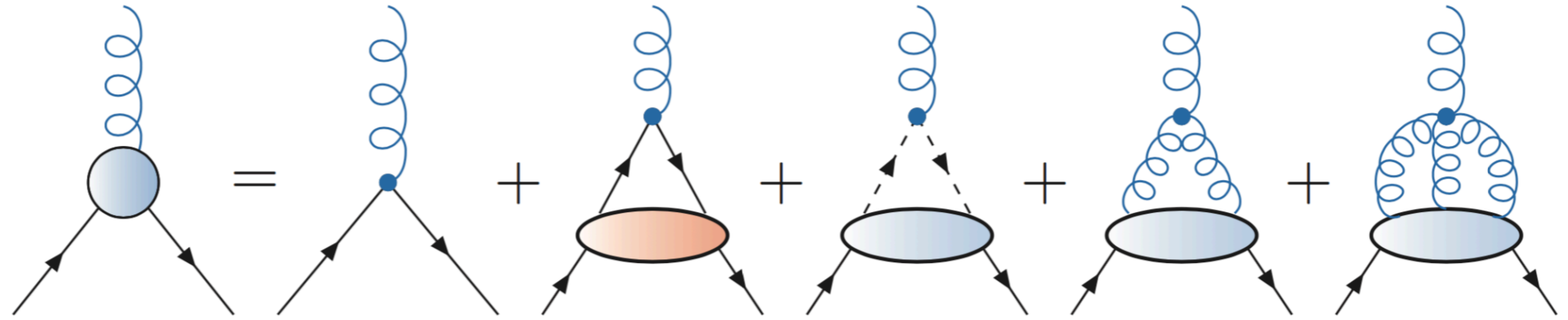

quark:

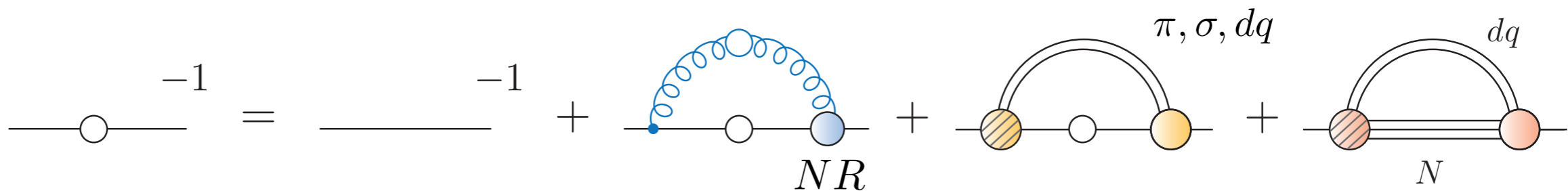

Eichmann, CF, Welzbacher, PRD93 (2016) [1509.02082]

Hadron effects in quark-gluon interaction

quark-gluon
vertex:

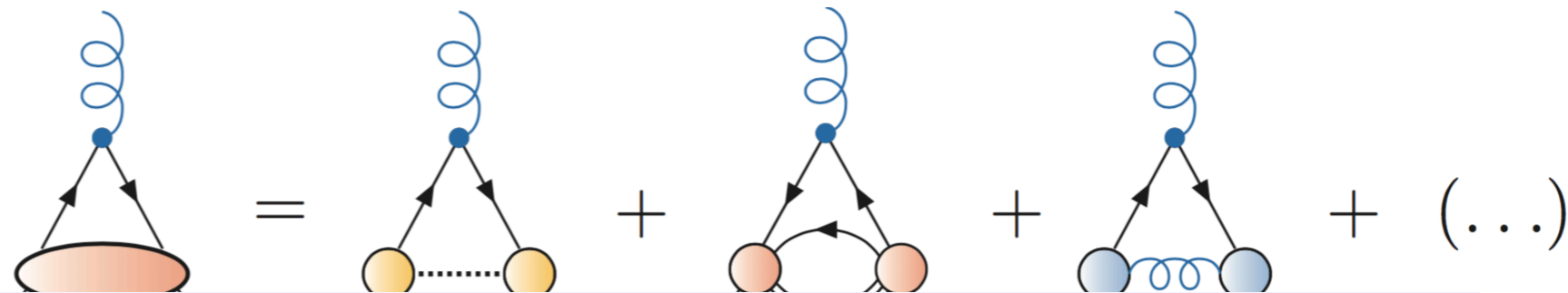
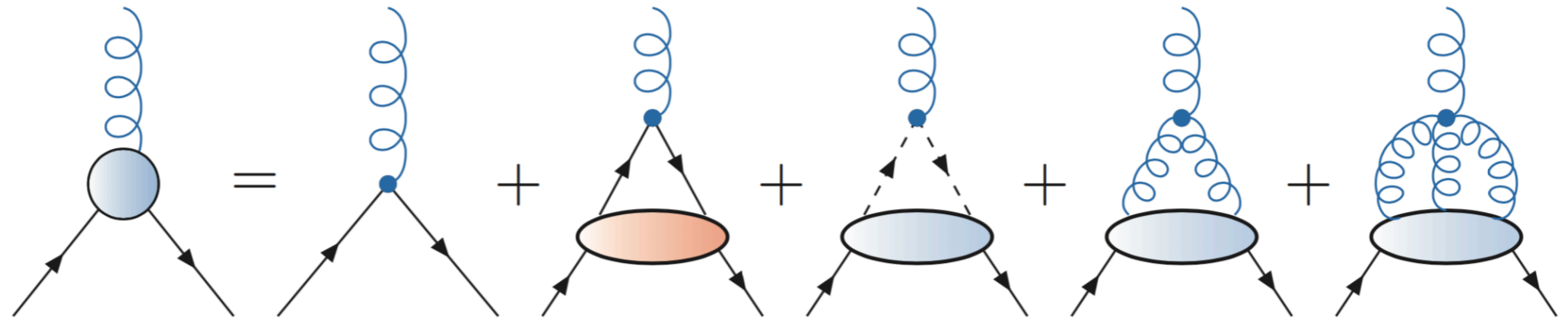

quark

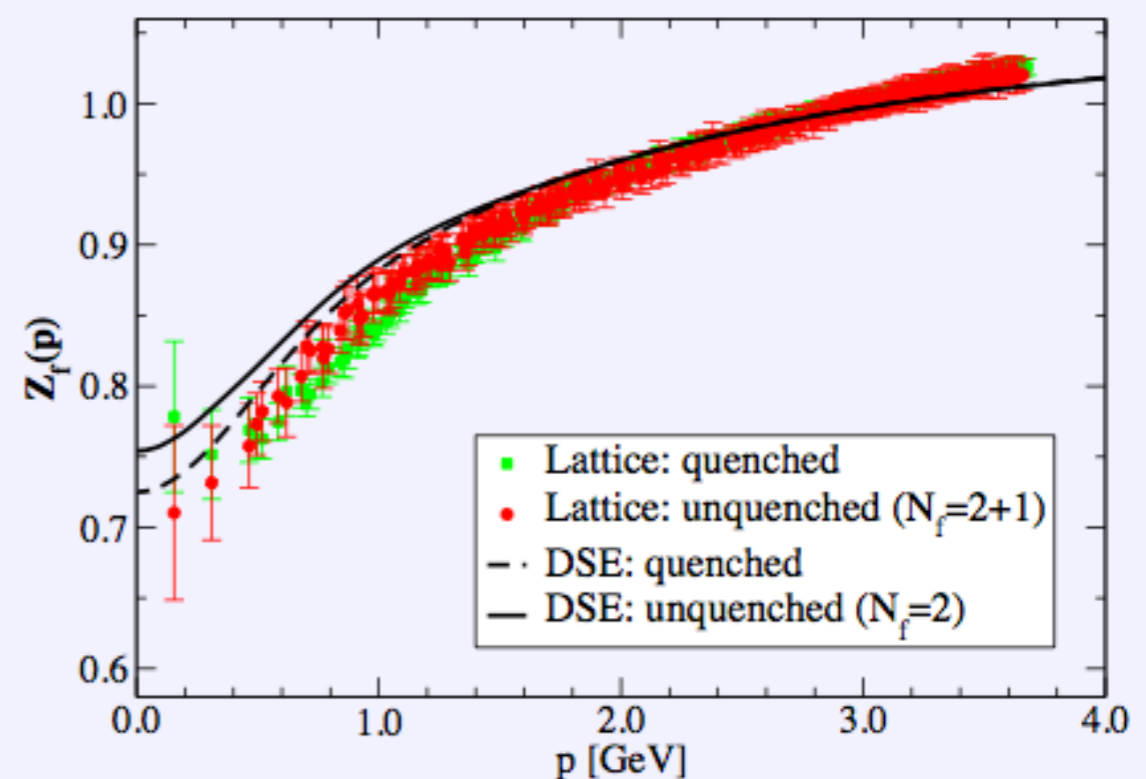
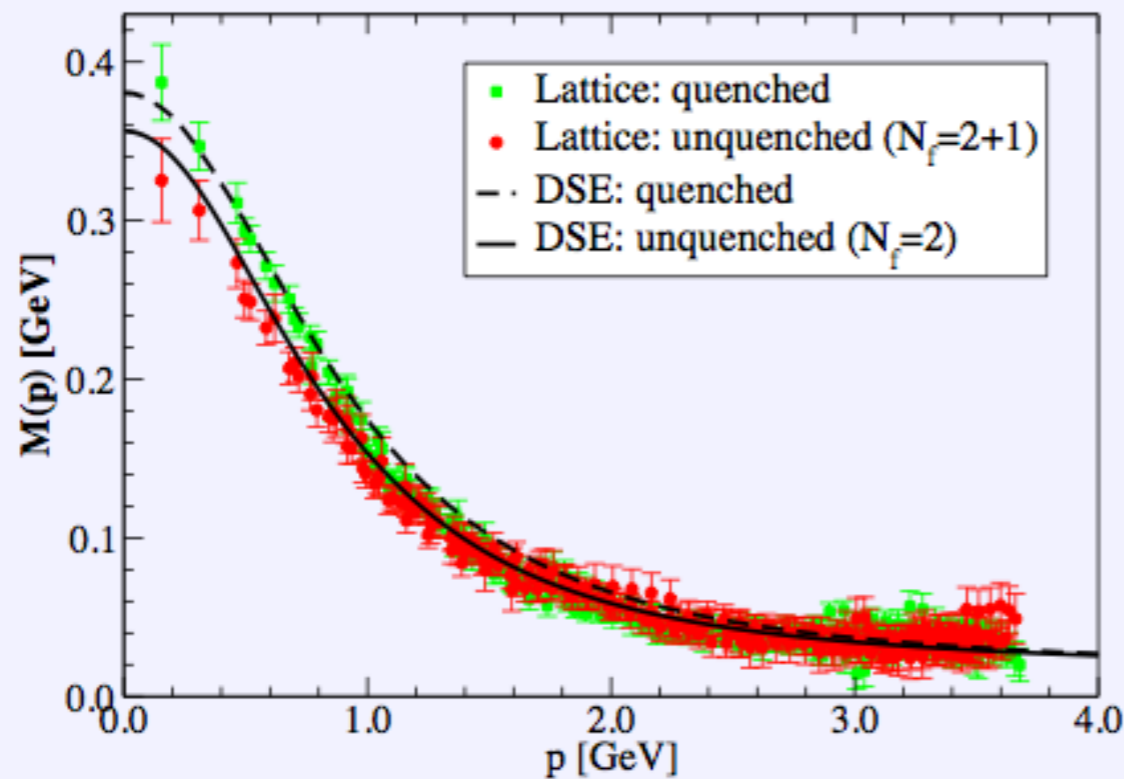

CF, D. Nickel and R. Williams, EPJC 60, 1434 (2008)

2]

Hadron effects onto quark

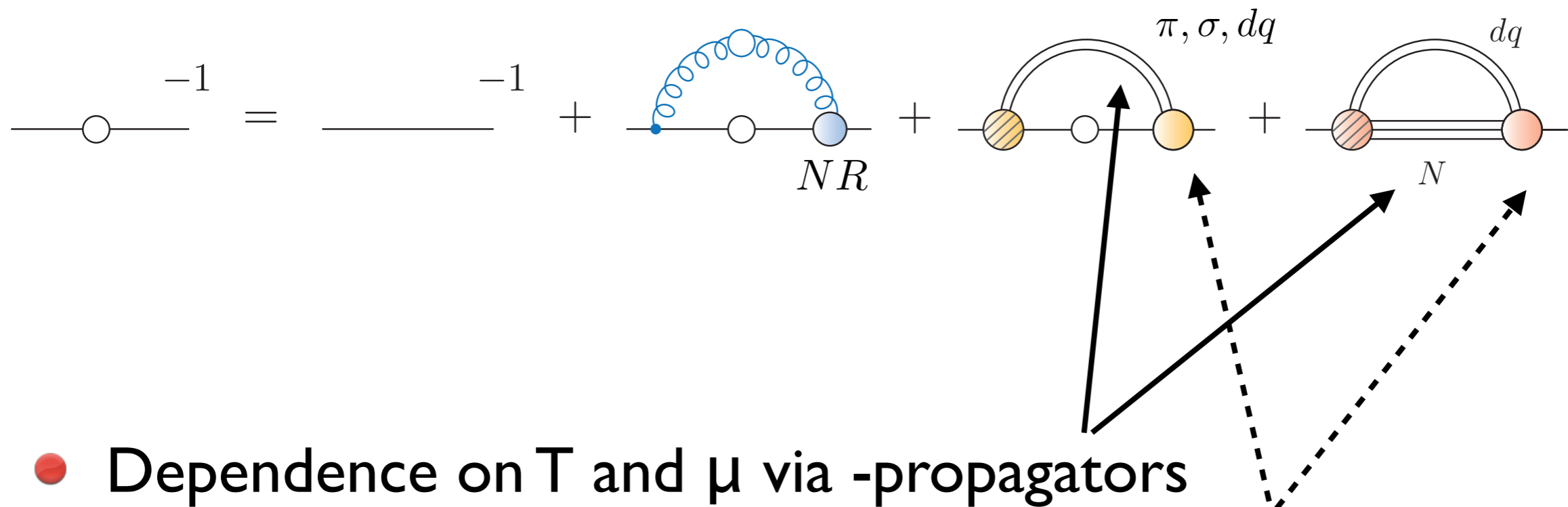

- Dependence on T and μ via π -propagators
-wave functions
- Exploratory calculation: use wave functions from $T=\mu=0$

Vacuum: Light baryon spectrum

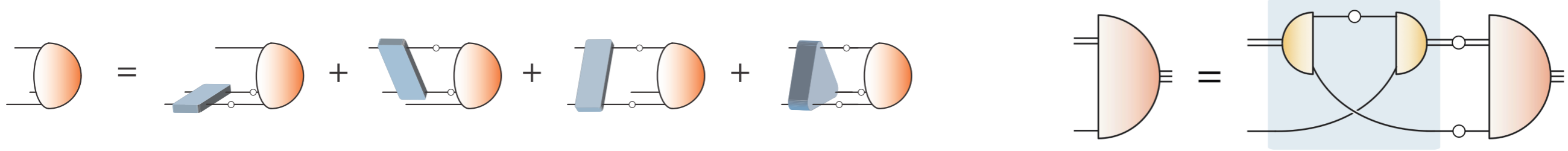

M [GeV]

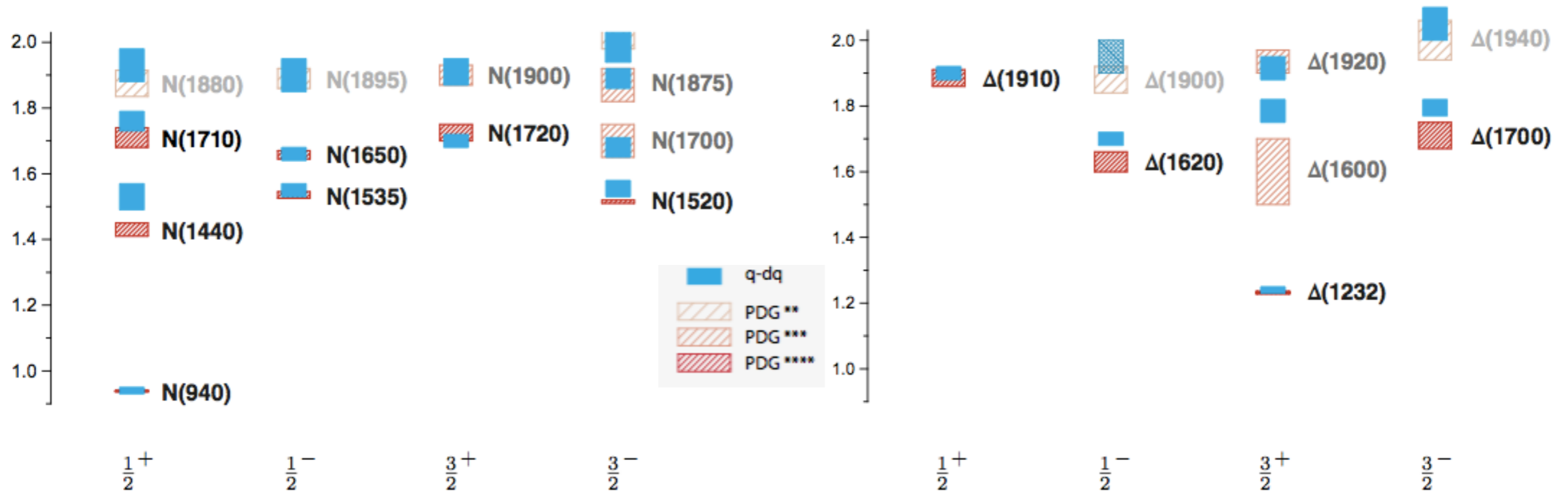

Eichmann, CF, Sanchis-Alepuz, PRD 94 (2016) [1607.05748]

Eichmann, CF, in preparation

Vacuum: Light baryon spectrum

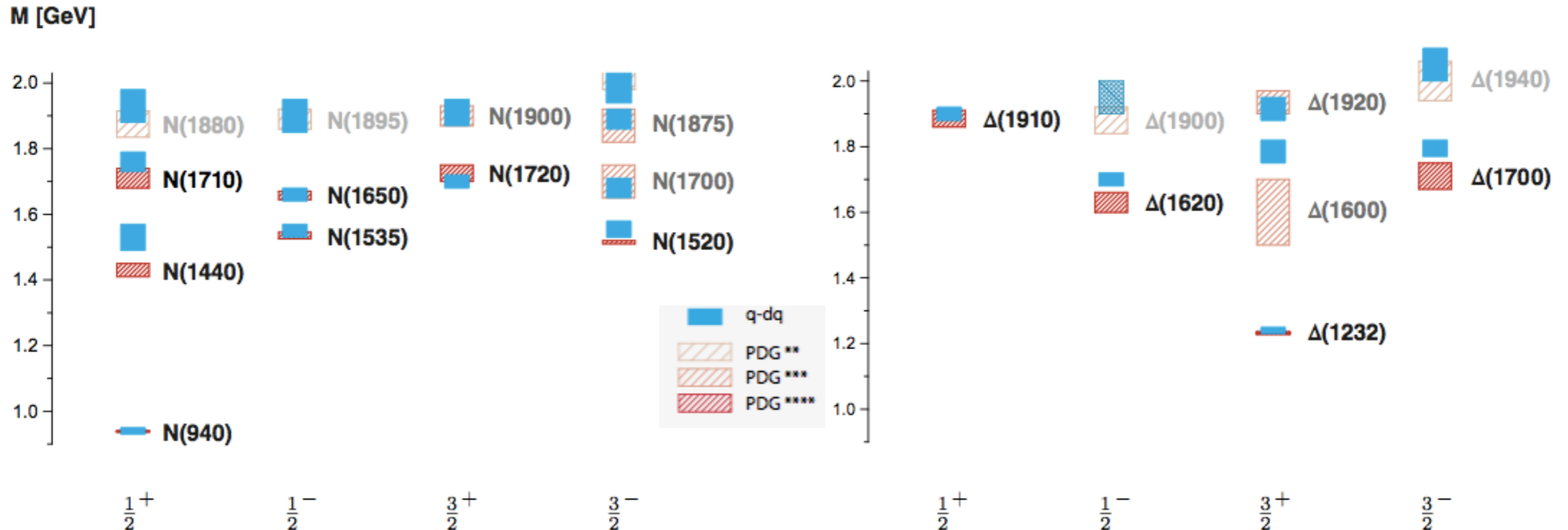
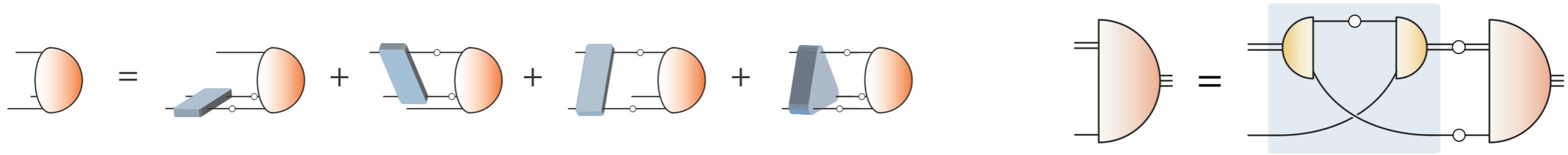

Eichmann, CF, Sanchis-Alepuz, PRD 94 (2016) [1607.05748]
 Eichmann, CF, in preparation

- Spectrum in one-to-one agreement with experiment
- Correct level ordering (wo. coupled channel effects) !

Hadron effects on the CEP - results ($N_f=2$)

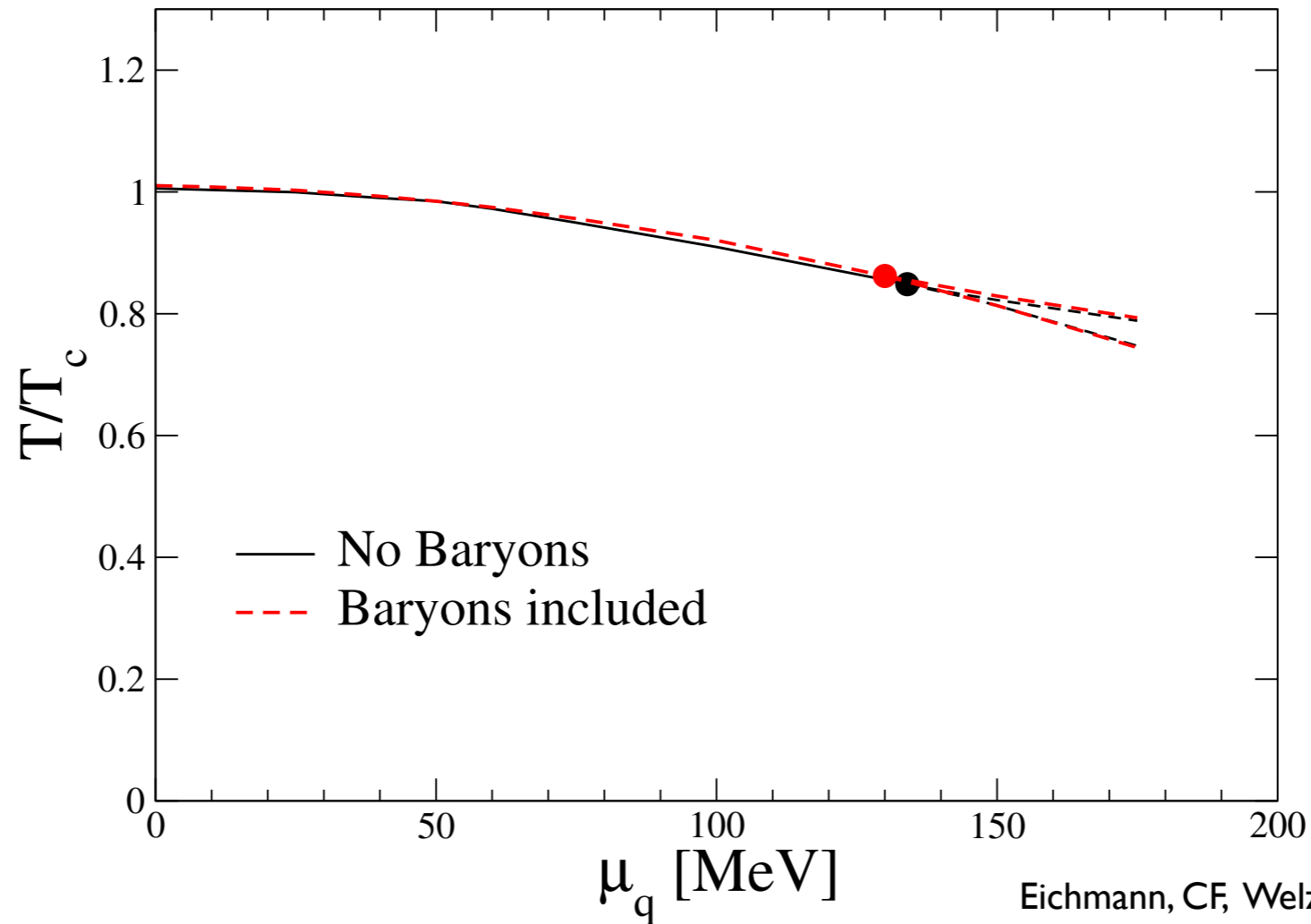
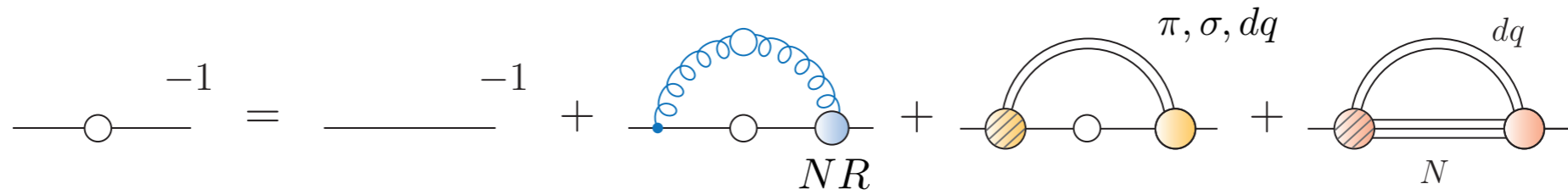

Eichmann, CF, Welzbacher, PRD93 (2016) [1509.02082]
Luecker, PhD-thesis, JLU Giessen, 2013

- Zero chemical potential: no effect
- almost no effect on location of CEP (mesons: similar)

Hadron effects on the CEP - results ($N_f=2$)

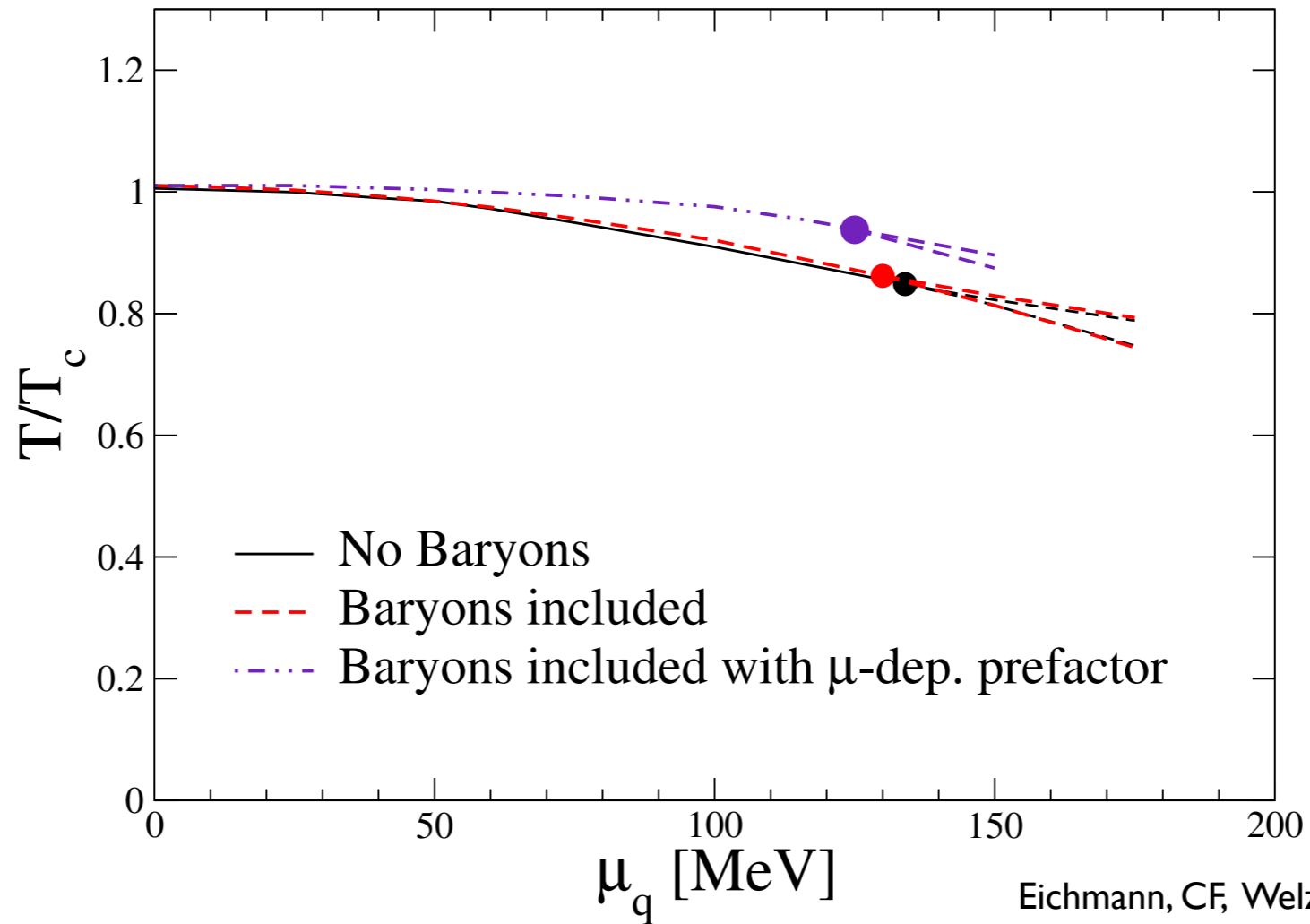
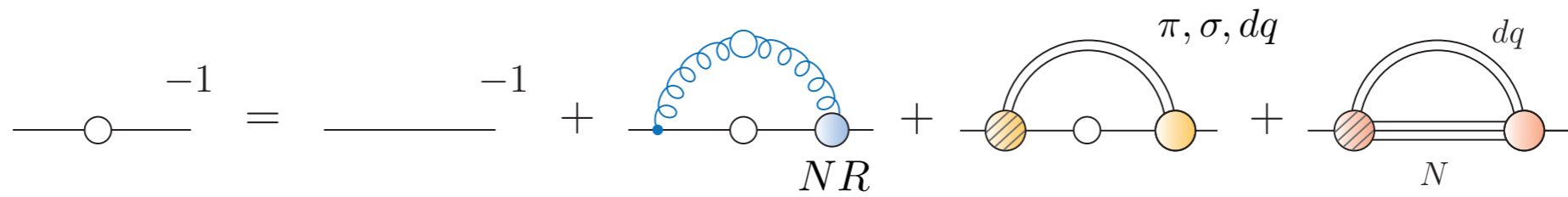

Eichmann, CF, Welzbacher, PRD93 (2016) [1509.02082]
Luecker, PhD-thesis, JLU Giessen, 2013

- Zero chemical potential: no effect
- almost no effect on location of CEP (mesons: similar)
- But: strong μ -dependence of baryon wave function may change situation...

Meson effects at finite T and μ

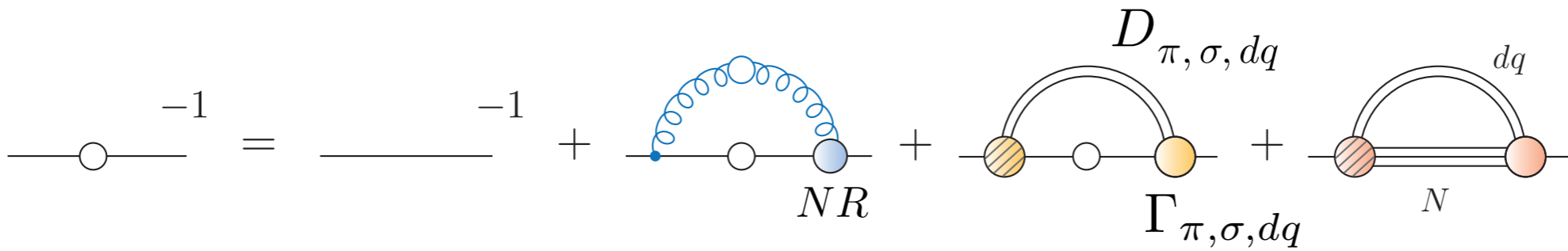

$$D_\pi(p) = \frac{1}{p_4^2 + u^2(\vec{p}^2 + m_\pi(T, \mu)^2)}$$

$$u = \frac{f_s}{f_t}$$

Son, Stephanov, PRD 66 (2002) 7

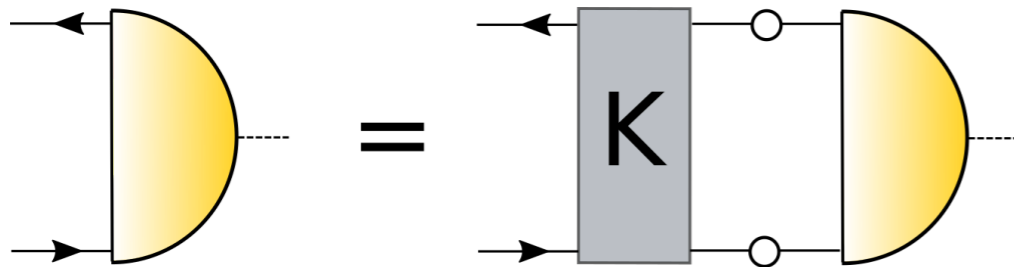

$$\Gamma_\pi(P, q) = \gamma_5 E(P, q, T, \mu) + \dots$$

chiral limit: $\Gamma_\pi = \gamma_5 \frac{B}{f_t}$

Critical scaling from DSEs: $N_f=2$, chiral limit

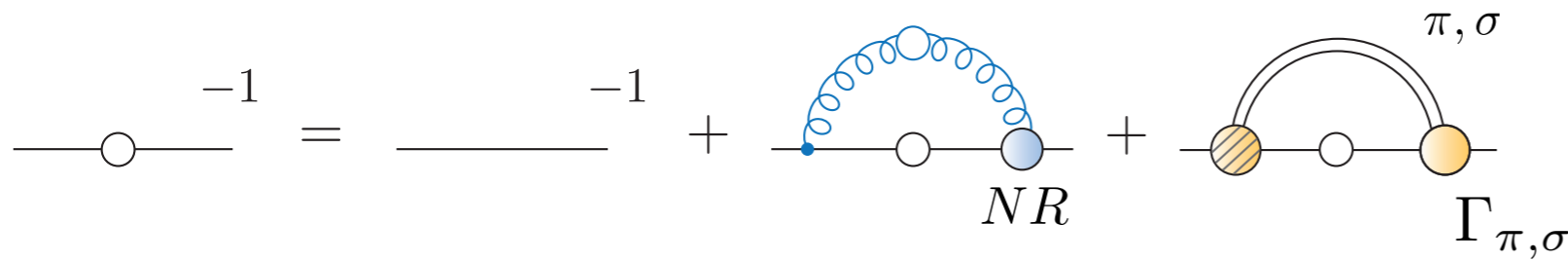
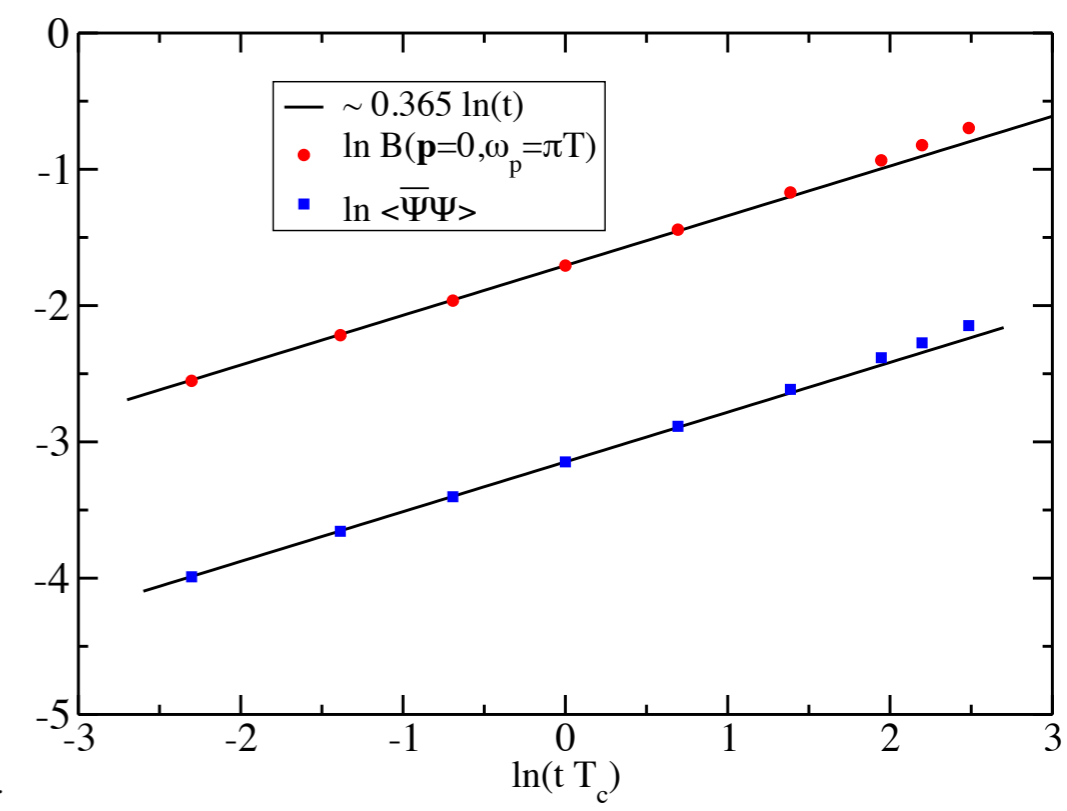
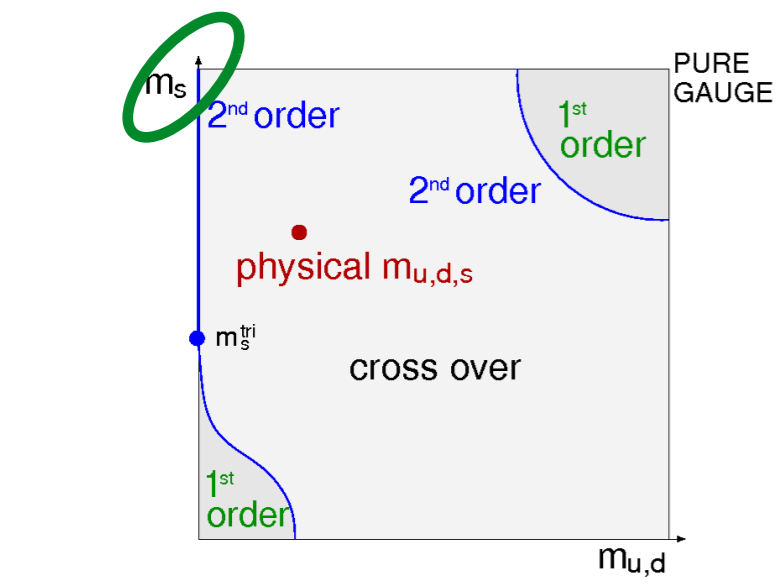

- $T=0$: meson contributions of order of 10-20 %

CF, Nickel, Williams EPJC 60 1434 (2008); CF, Williams, PRD 78 (2008) 074006

- $T=T_c$: meson contributions are dominant - universality !

- Critical scaling: $\langle \bar{\Psi}\Psi \rangle(t) \sim B(t) \sim t^{\nu/2}$
 $f_{\pi,s}^2 \sim t^{\nu}$

$$t := \frac{T_c - T}{T_c}$$

CF and Mueller, PRD 84 (2011) 054013

Pion properties at finite chemical potential

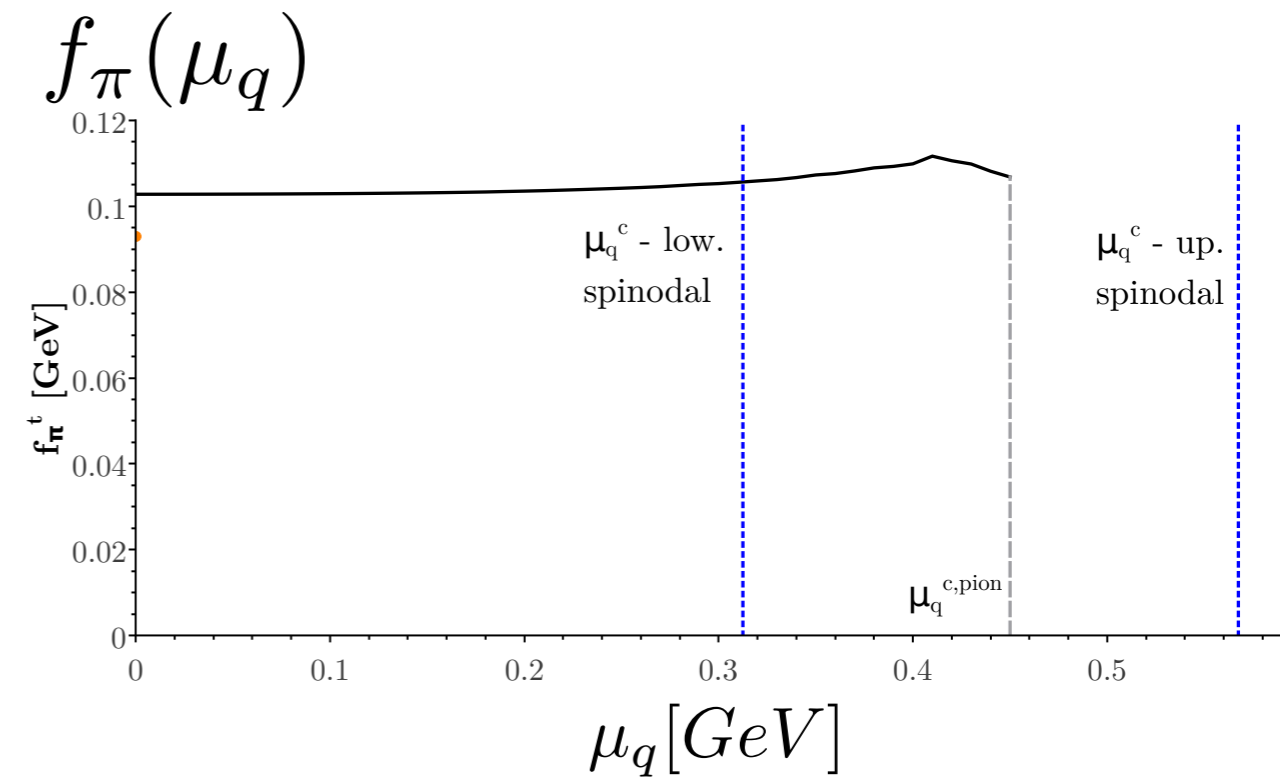
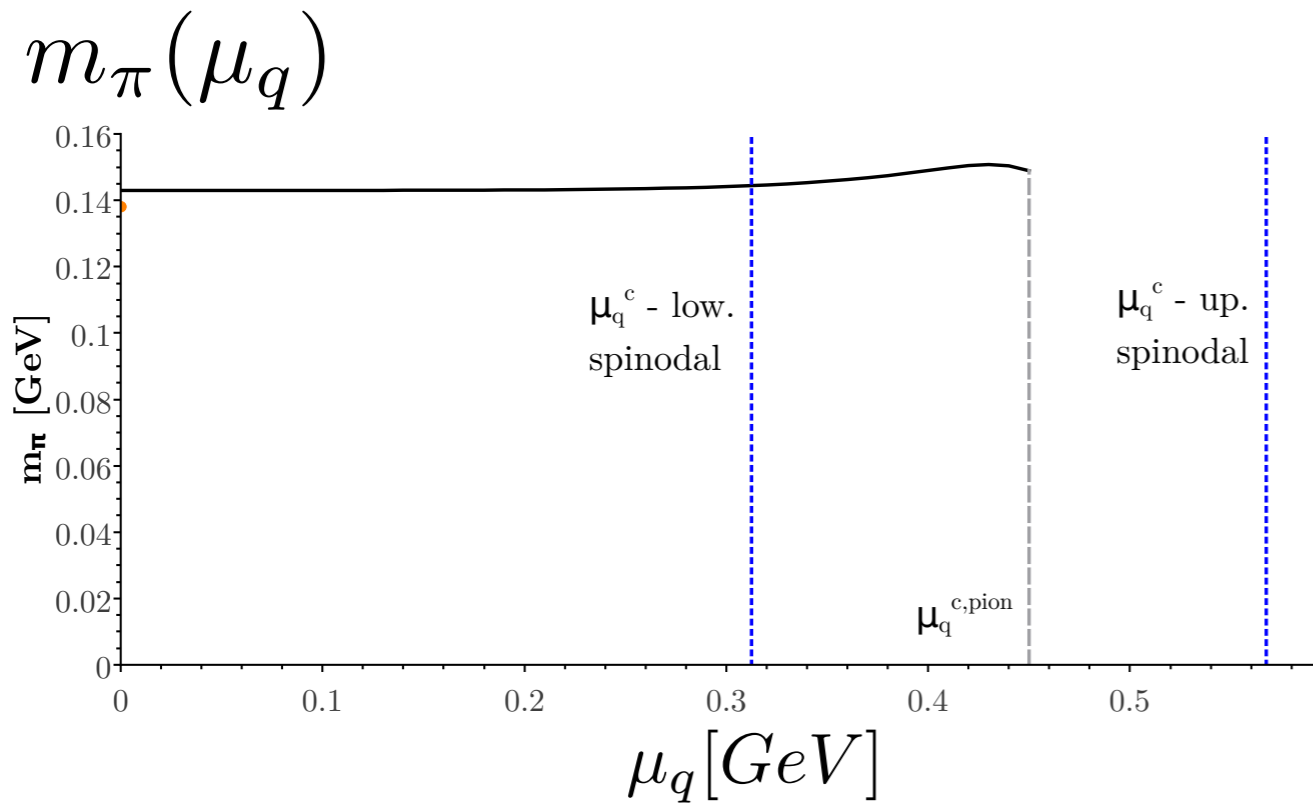
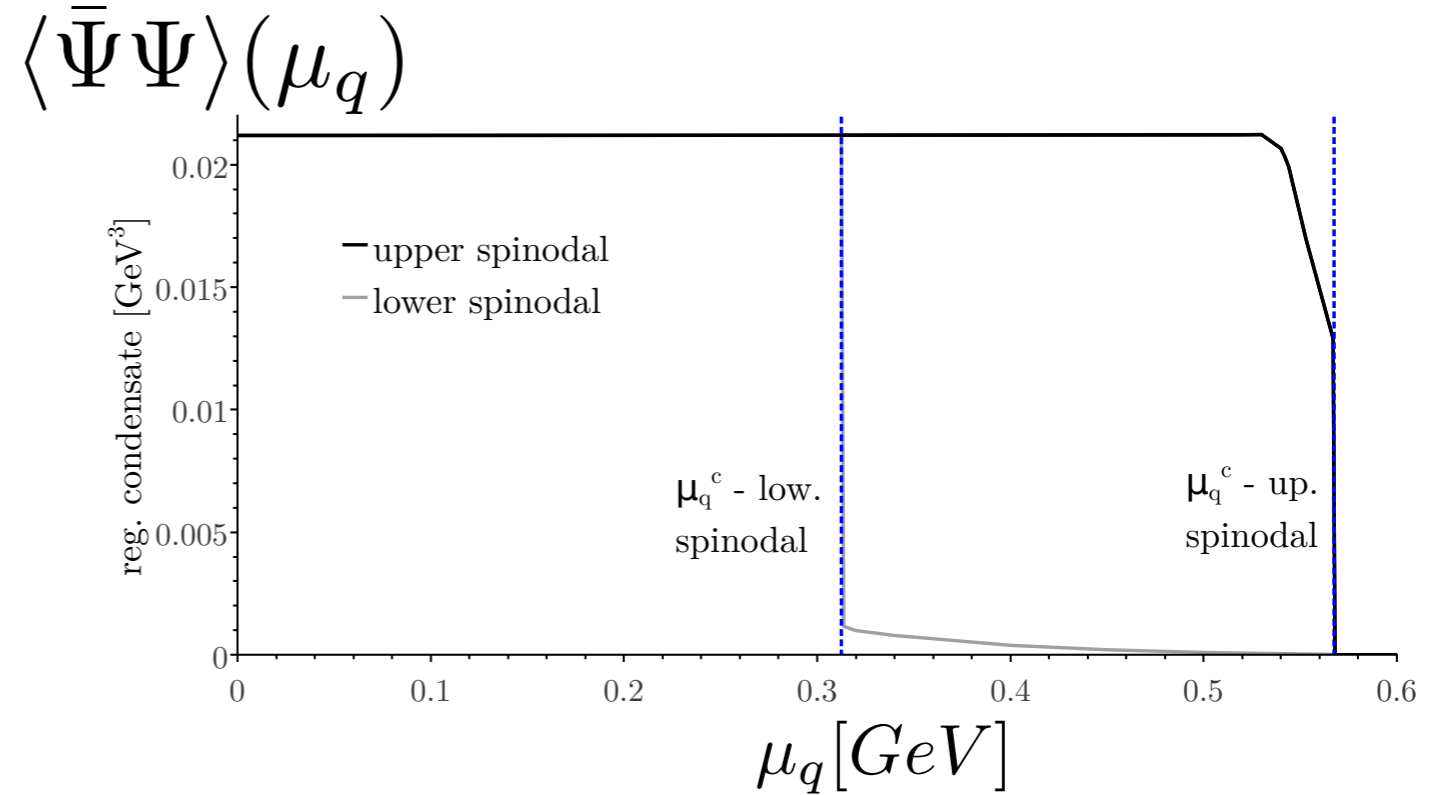
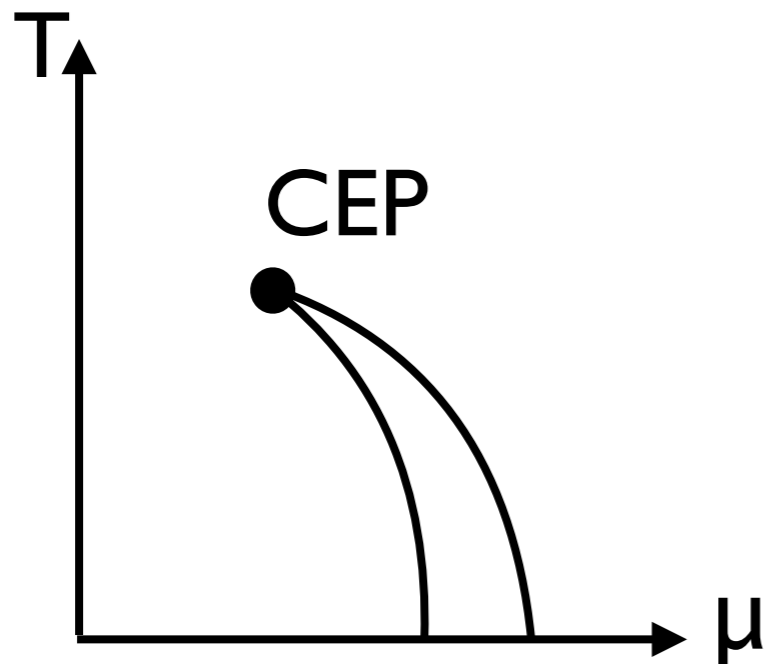

P. Gunkel, CF, work in progress

● Silver blaze satisfied

T. D. Cohen, PRL 91, 222001 (2003)

cf. also D. Mueller, PhD-thesis, TU Darmstadt 2013

QCD with finite chemical potential:

- back-reaction of quarks onto gluons important
- $N_f=2+1$ and $N_f=2+1+1$: CEP at $\mu_c/T_c > 3$
- charm quark does not influence CEP
- Baryon effects may or may not be significant for CEP...

Work in progress: - mesons and baryons at finite T and μ

w. Pascal Gunkel

- thermodynamics and fluctuations

w. Phillip Isserstedt

- quark spectral functions

CF, Pawłowski, Rothkopf and Welzbacher, arXiv:1705.03207 [hep-ph]

Gluon electric screening mass: SU(2) vs. SU(3)

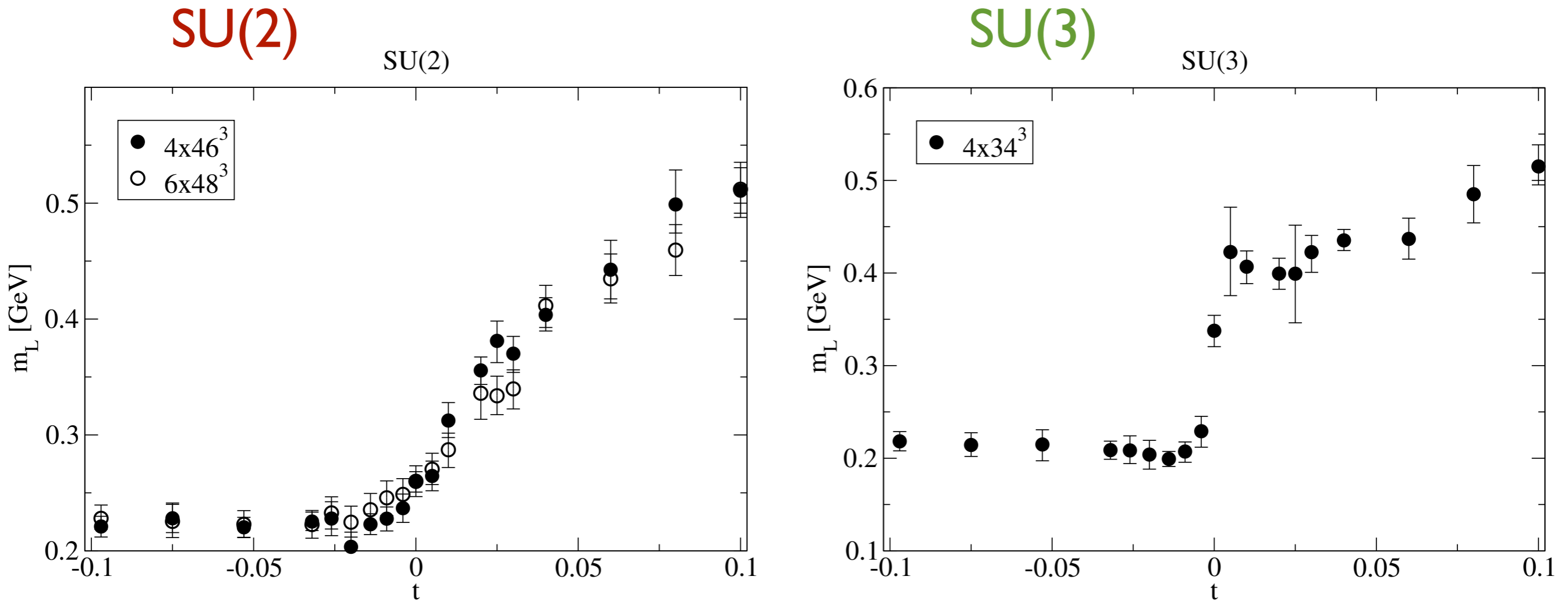

Maas, Pawłowski, Smekal, Spielmann, PRD 85 (2012) 034037
CF, Maas, Mueller, EPJC 68 (2010)

$$t = (T-T_c)/T_c$$

- phase transition of **second** and **first** order visible in electric screening mass

3PI-truncation

propagators

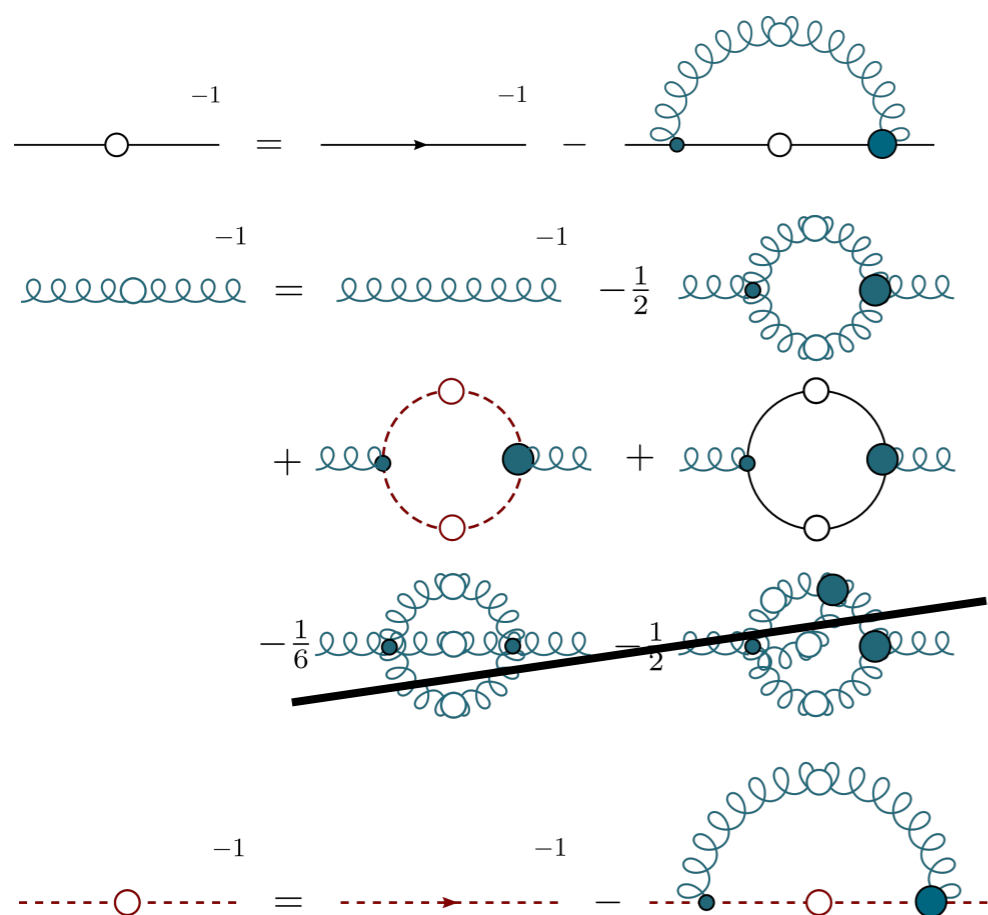

vertices

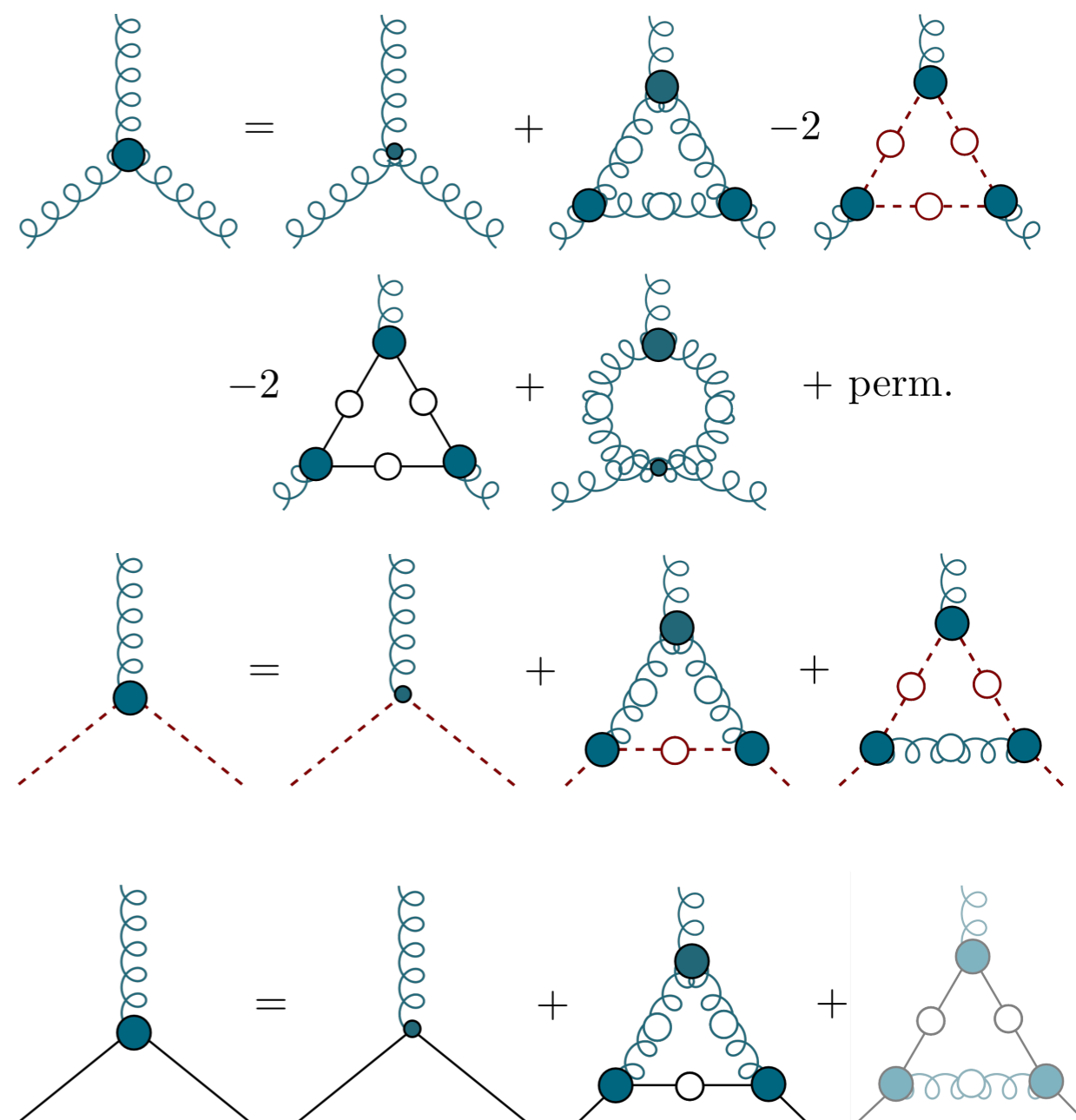

for different BRL approaches see work of
 Aguilar, Alkofer, Binosi, Blum, Chang, Cyrol, Eichmann, Fister,
 Huber, Maas, Mitter, Papavassiliou, Pawłowski, Roberts, Smekal,
 Strodthoff, Vujanovic, Watson, Williams...

Williams, CF, Heupel, PRD 93 (2016) 034026
 CF, Williams, PRL 103 (2009) 122001

Critical line/surface for heavy quarks

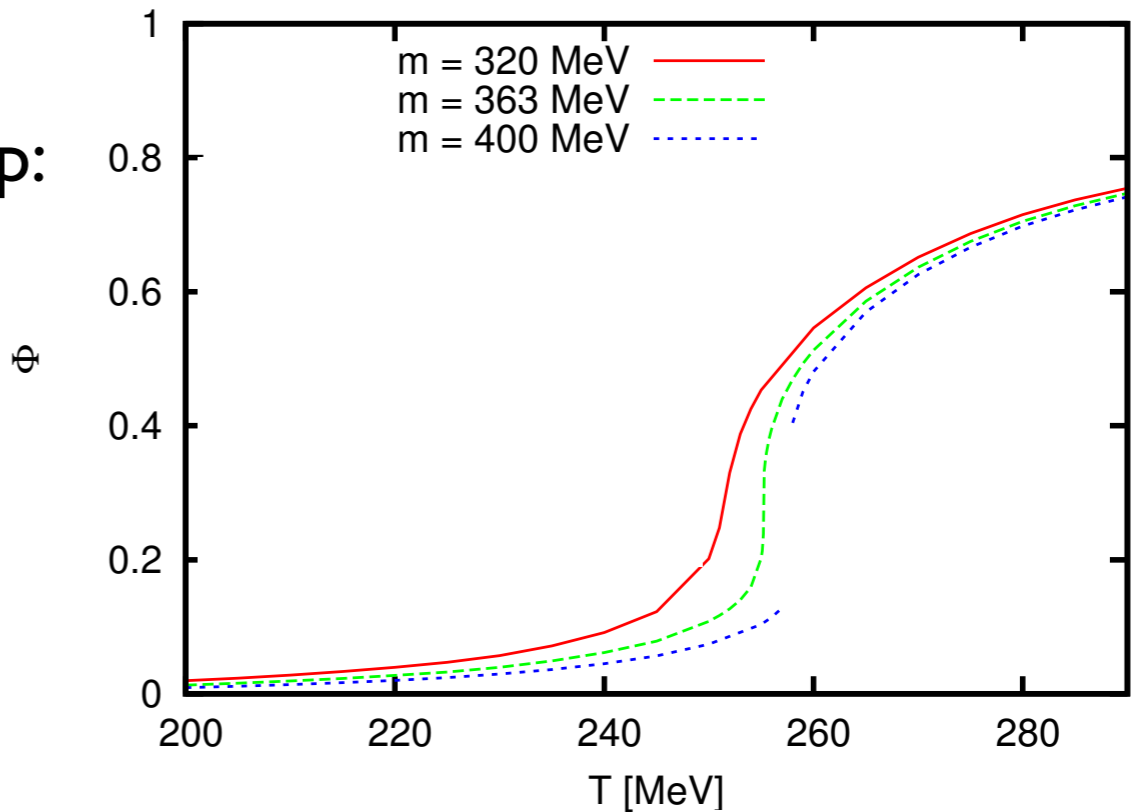
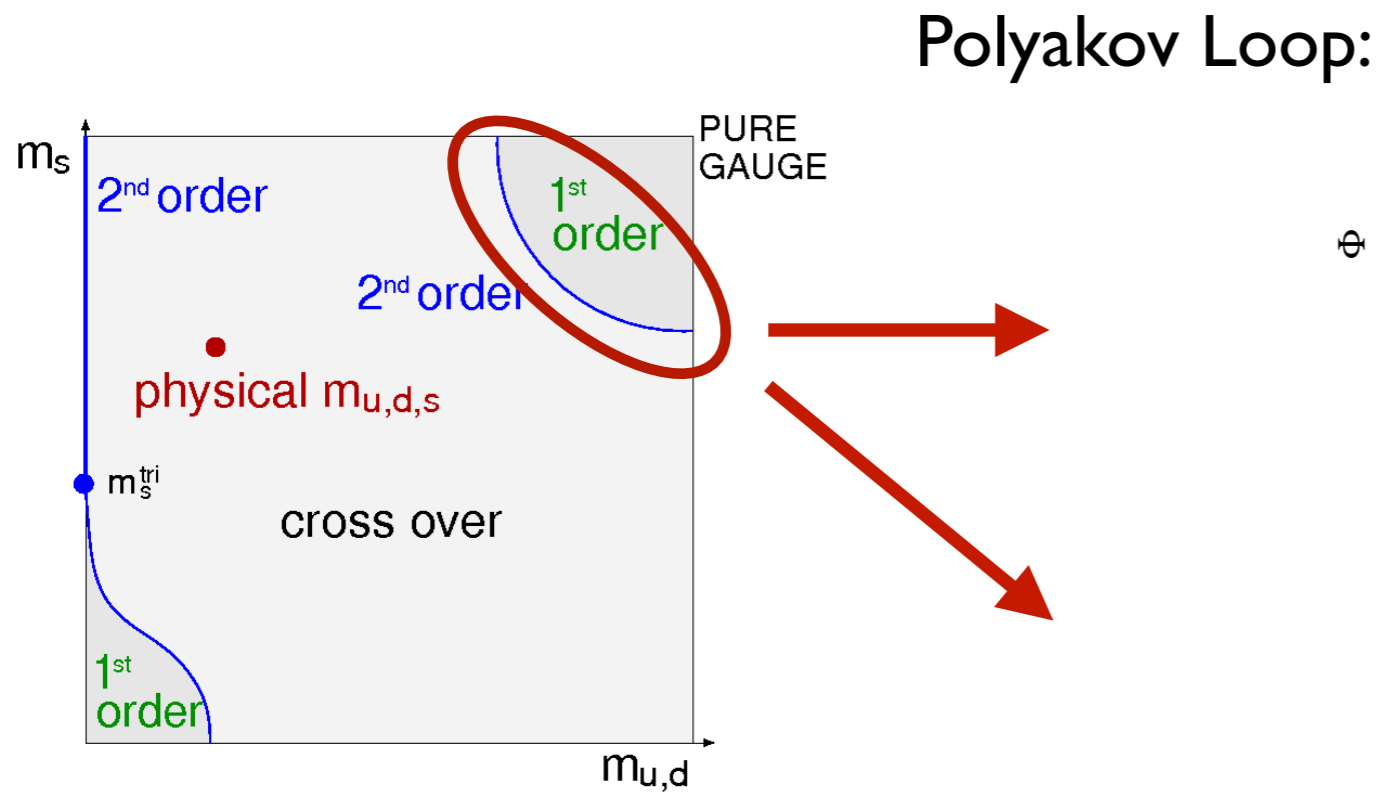

- Deconfinement transition in agreement with lattice QCD
- Correct tricritical scaling
- Roberge-Weiss-transition seen

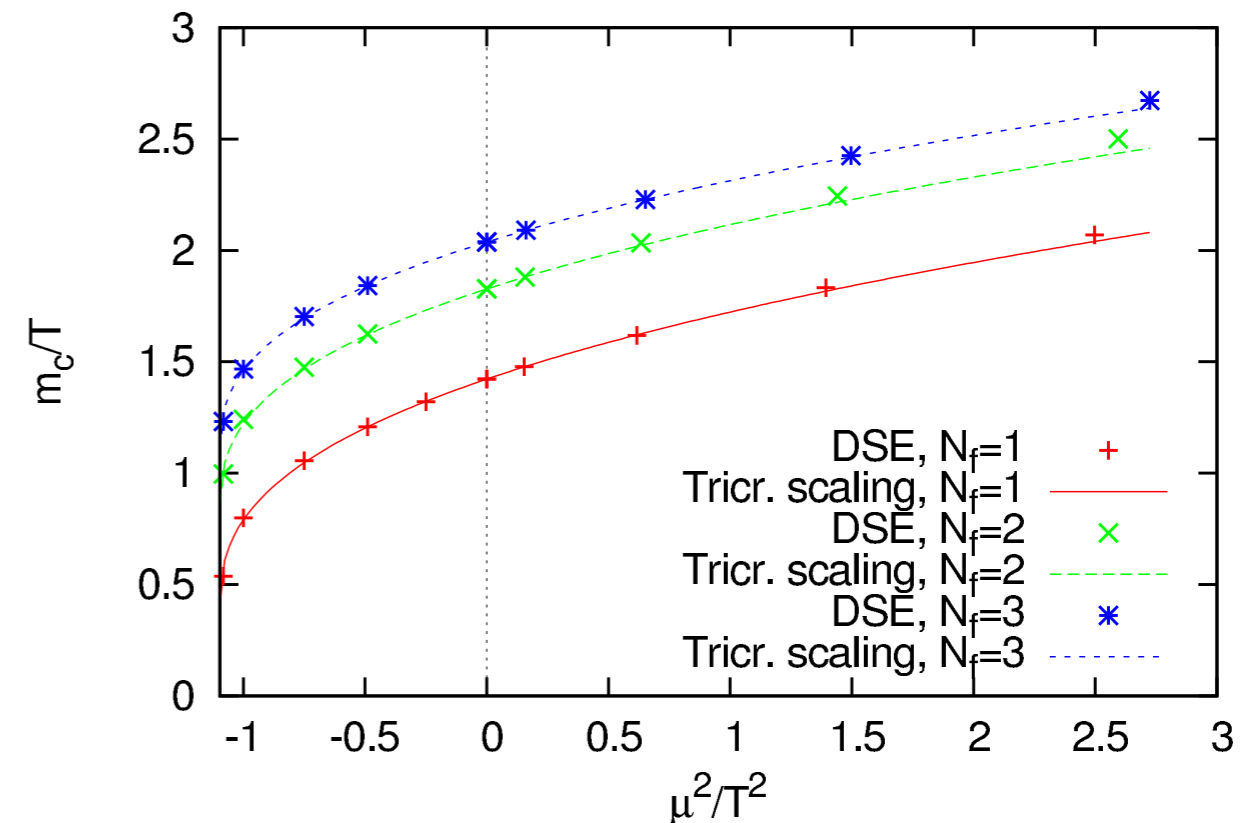

Lattice:
Fromm, Langelage, Lottini, Philipsen, JHEP 1201 (2012) 042

CF, Luecker, Pawlowski, PRD 91 (2015) 1

Critical line/surface for heavy quarks

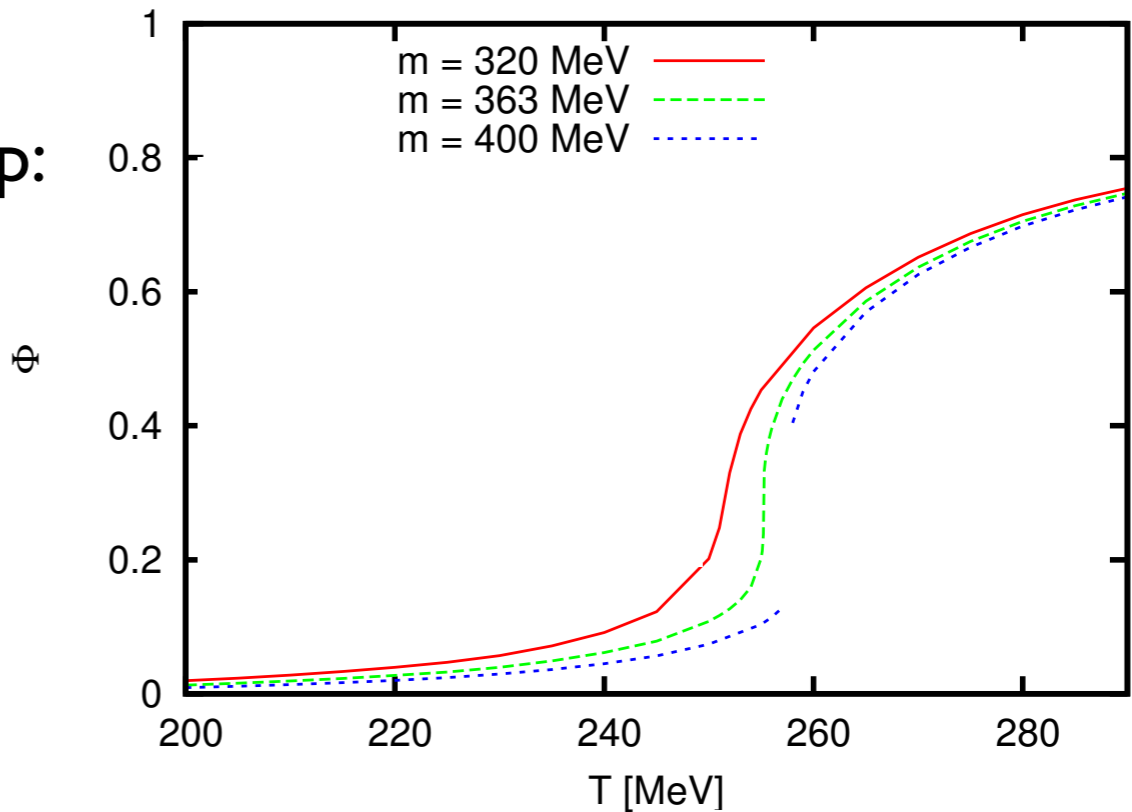
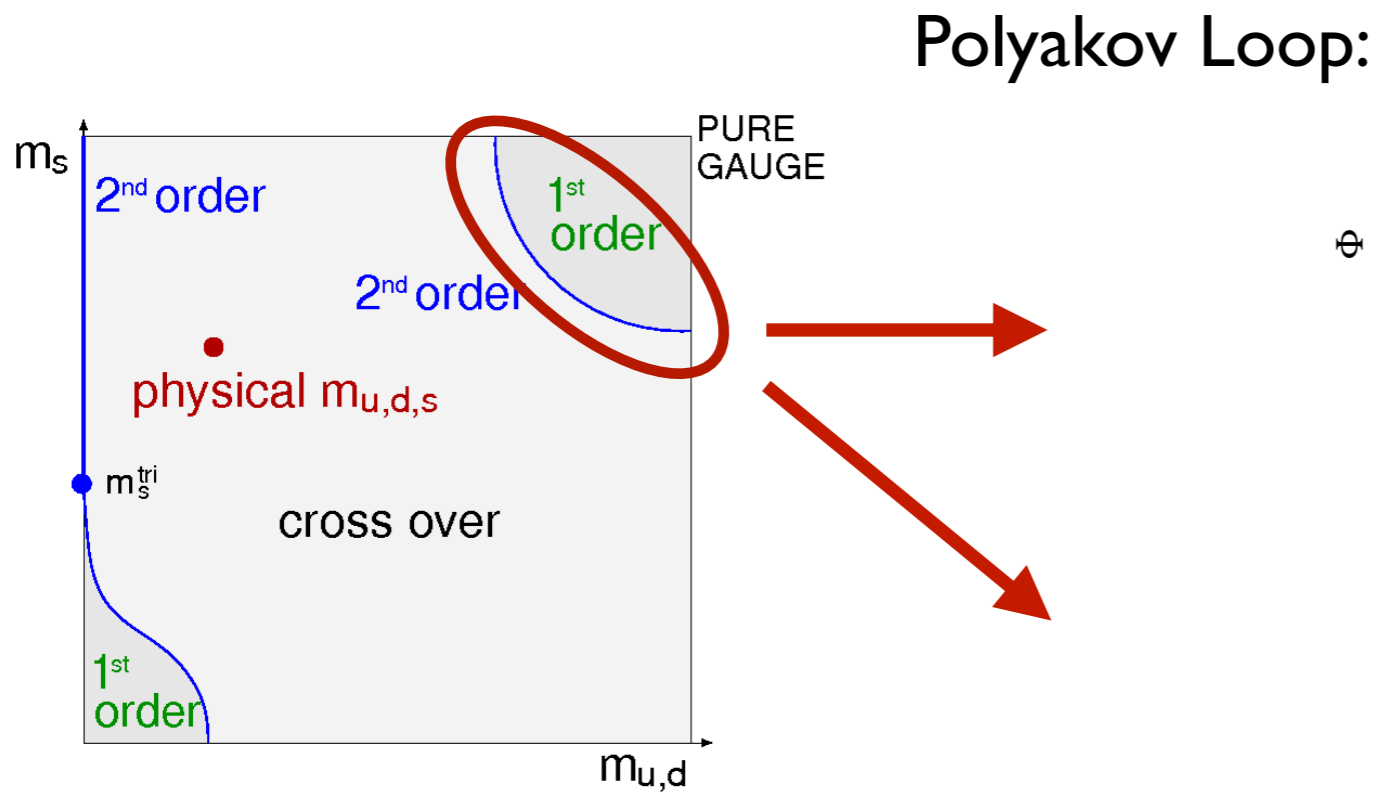

- Deconfinement transition in agreement with lattice QCD
- Correct tricritical scaling
- Roberge-Weiss-transition seen

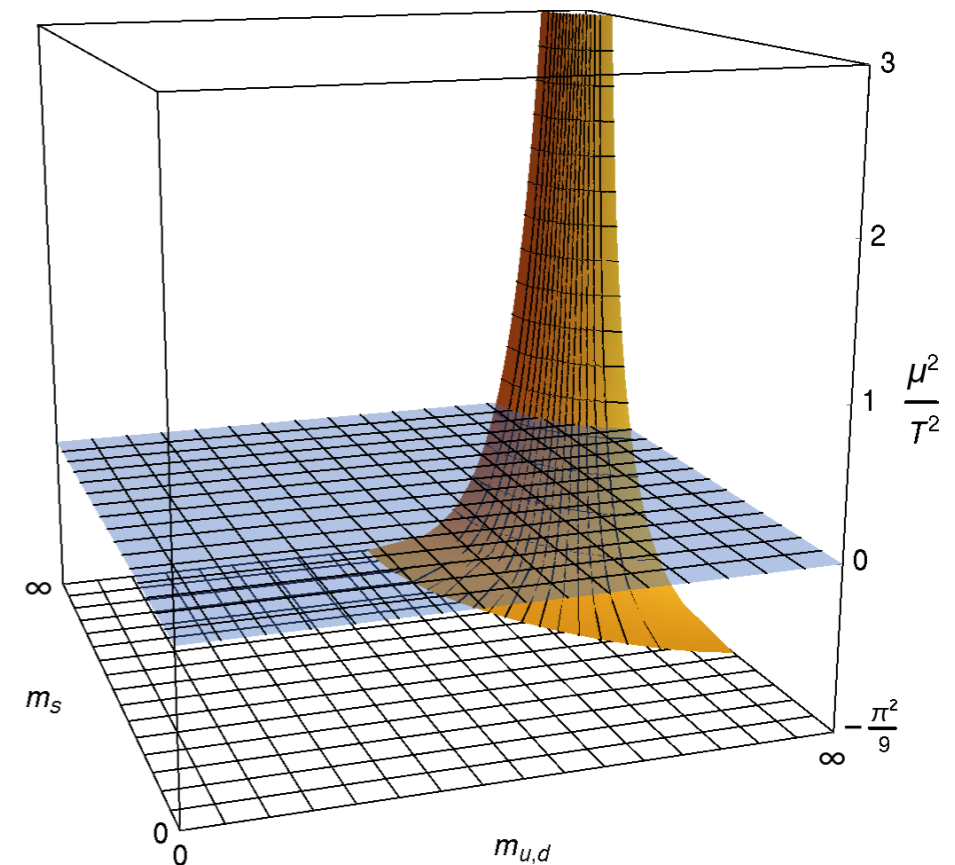

CF, Luecker, Pawlowski, PRD 91 (2015) 1

Lattice:
Fromm, Langelage, Lottini, Philipsen, JHEP 1201 (2012) 042

Critical line/surface for heavy quarks

Nf=2: CF and Mueller, PRD 84 (2011) 054013

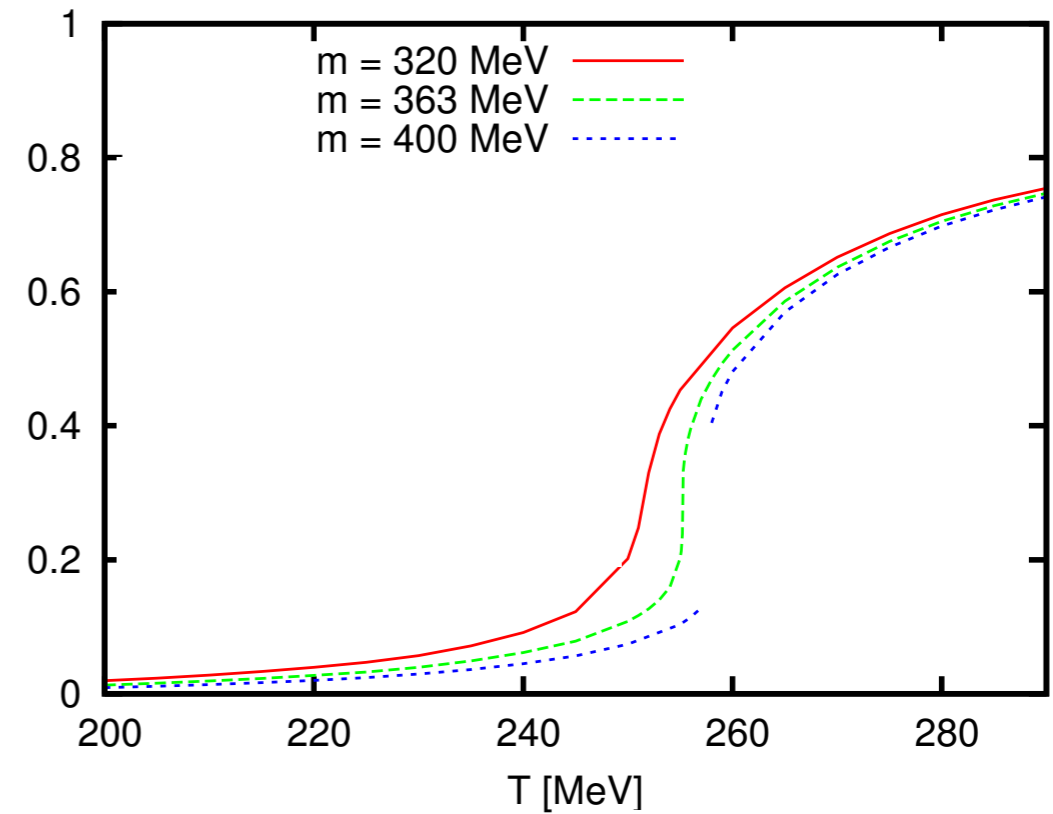
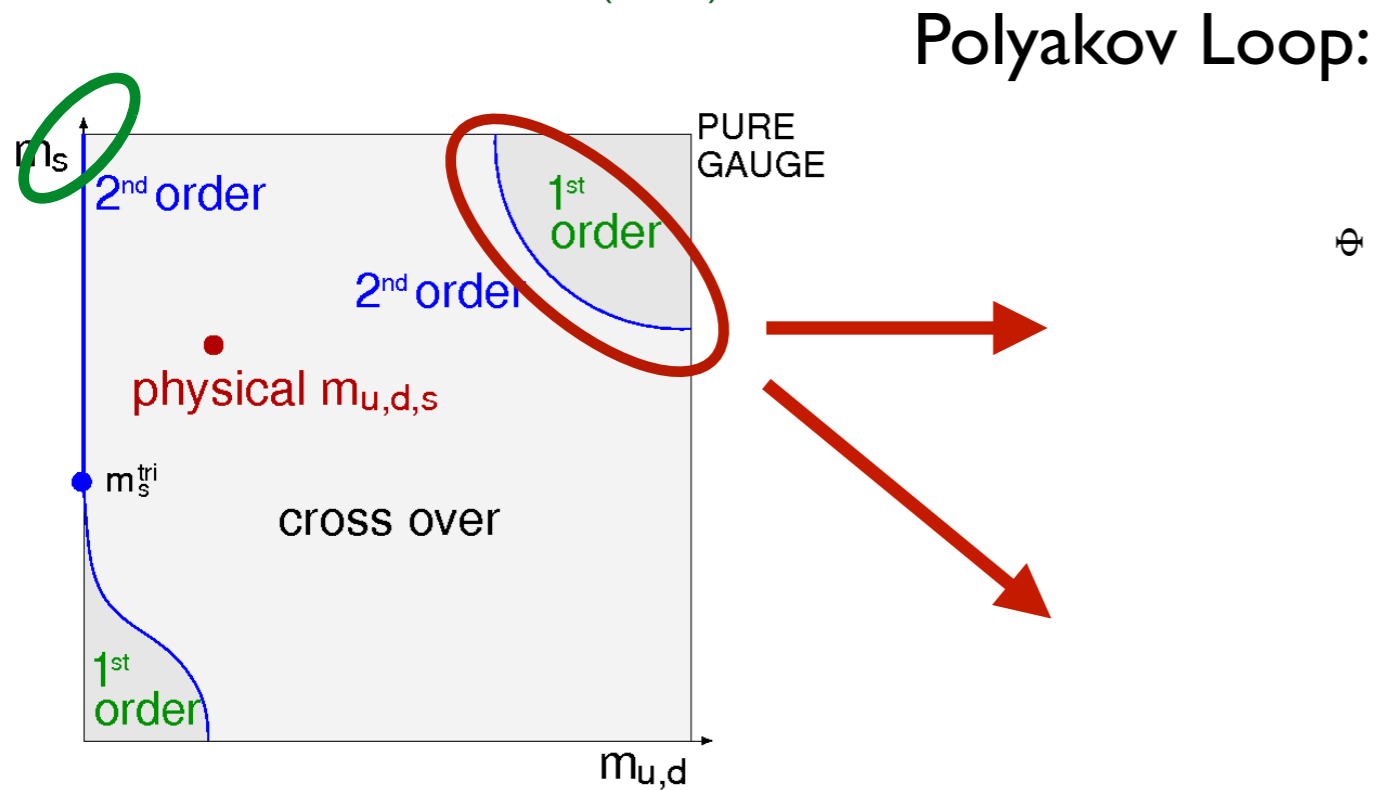

- Deconfinement transition in agreement with lattice QCD
- Correct tricritical scaling
- Roberge-Weiss-transition seen

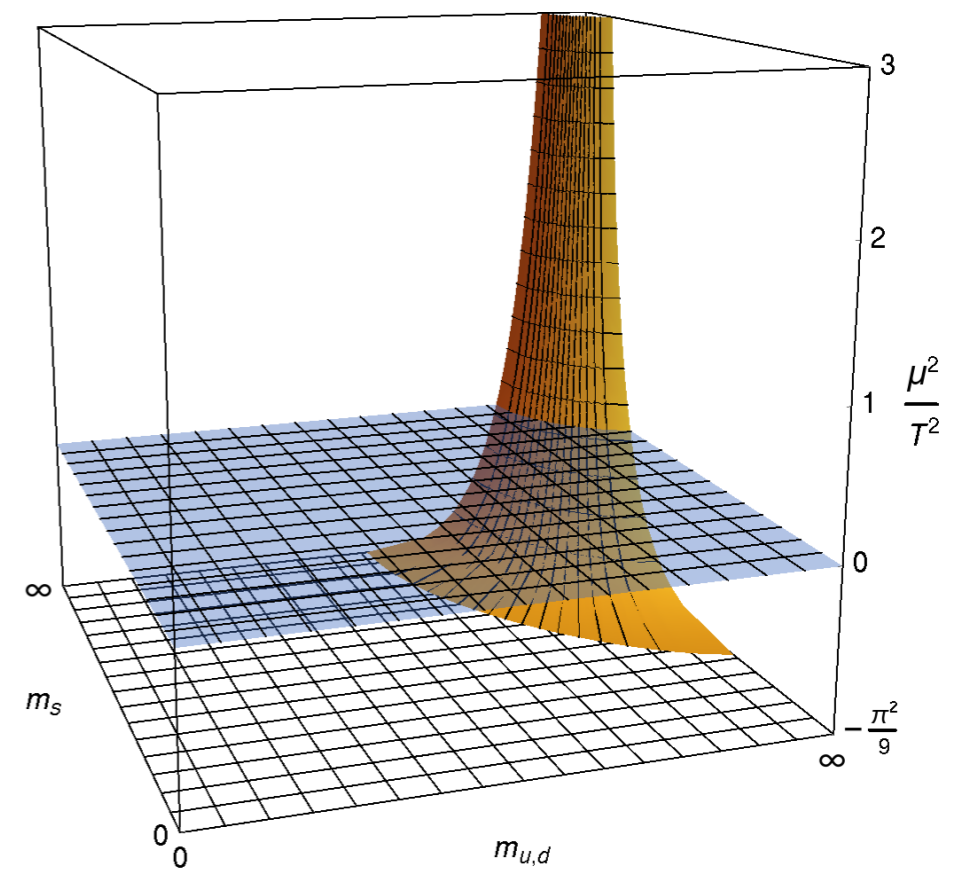

CF, Luecker, Pawlowski, PRD 91 (2015) 1

Lattice:
Fromm, Langelage, Lottini, Philipsen, JHEP 1201 (2012) 042

Nf=2+1: Condensate and dressed Polyakov Loop

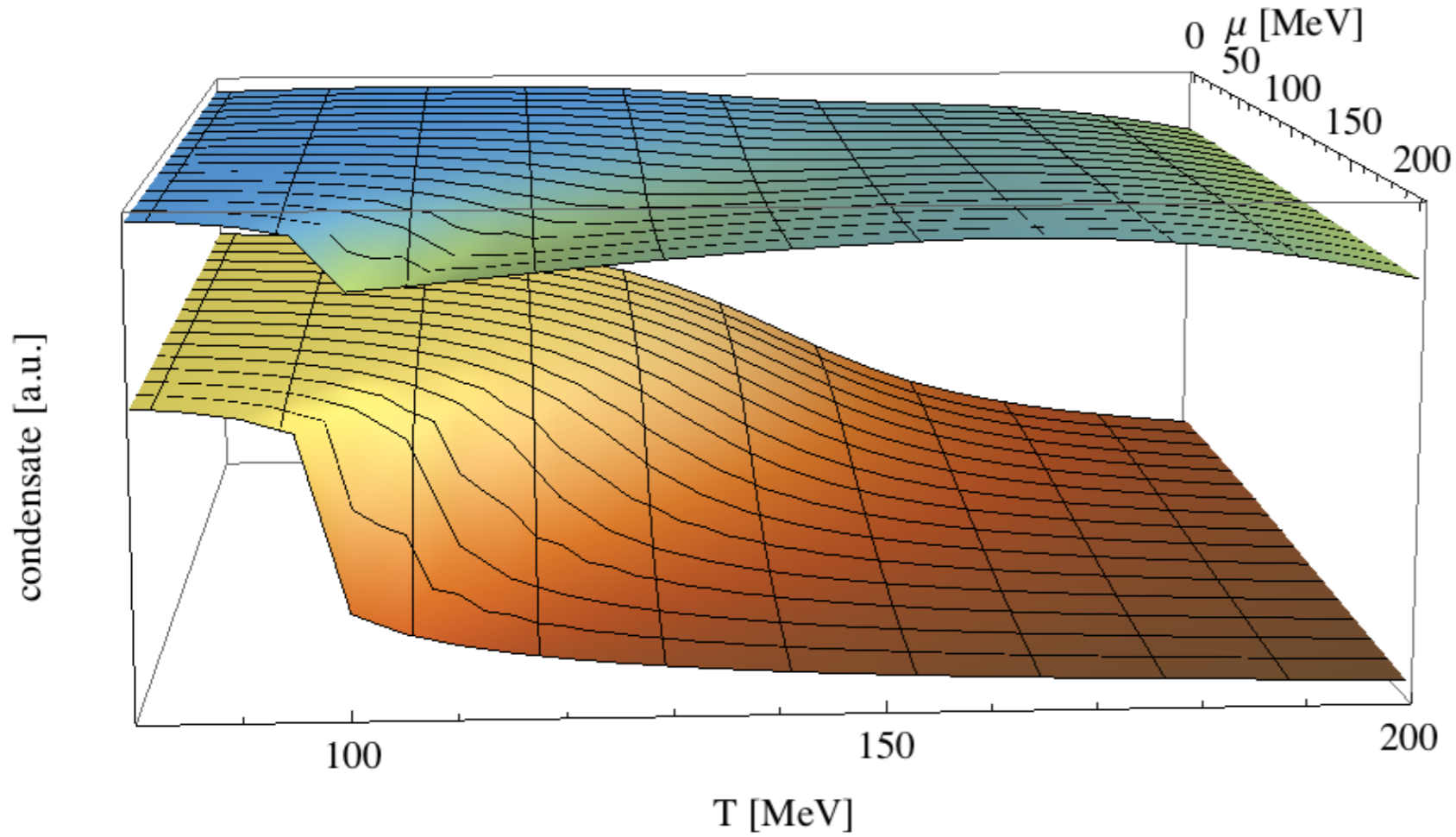

Quark condensate

Polyakov-Loop

$$L = \frac{1}{N_c} \text{tr} e^{ig \int A_0}$$

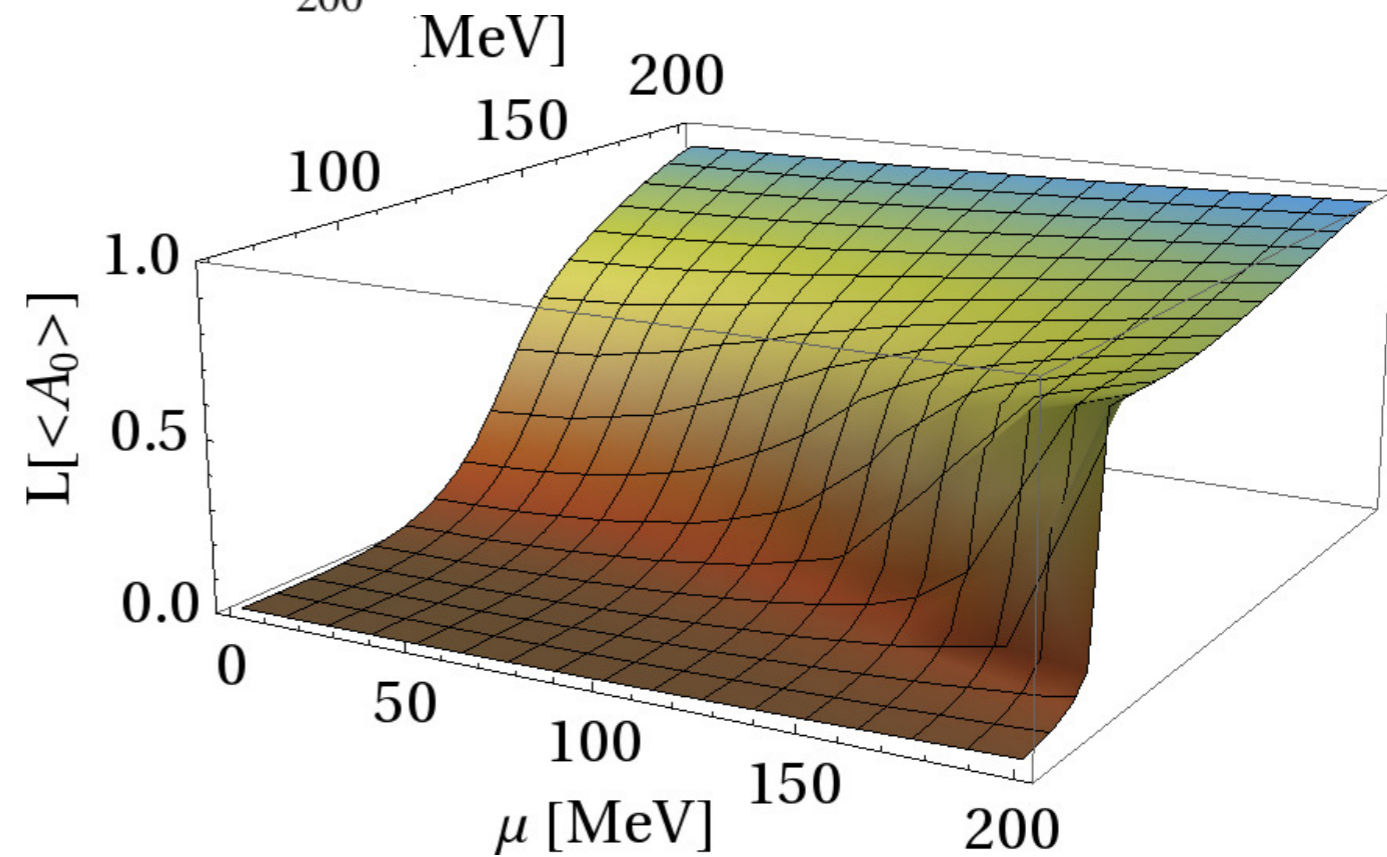

CF, Fister, Luecker, Pawłowski, PLB 732 (2014) 273

Baryons: Quark model

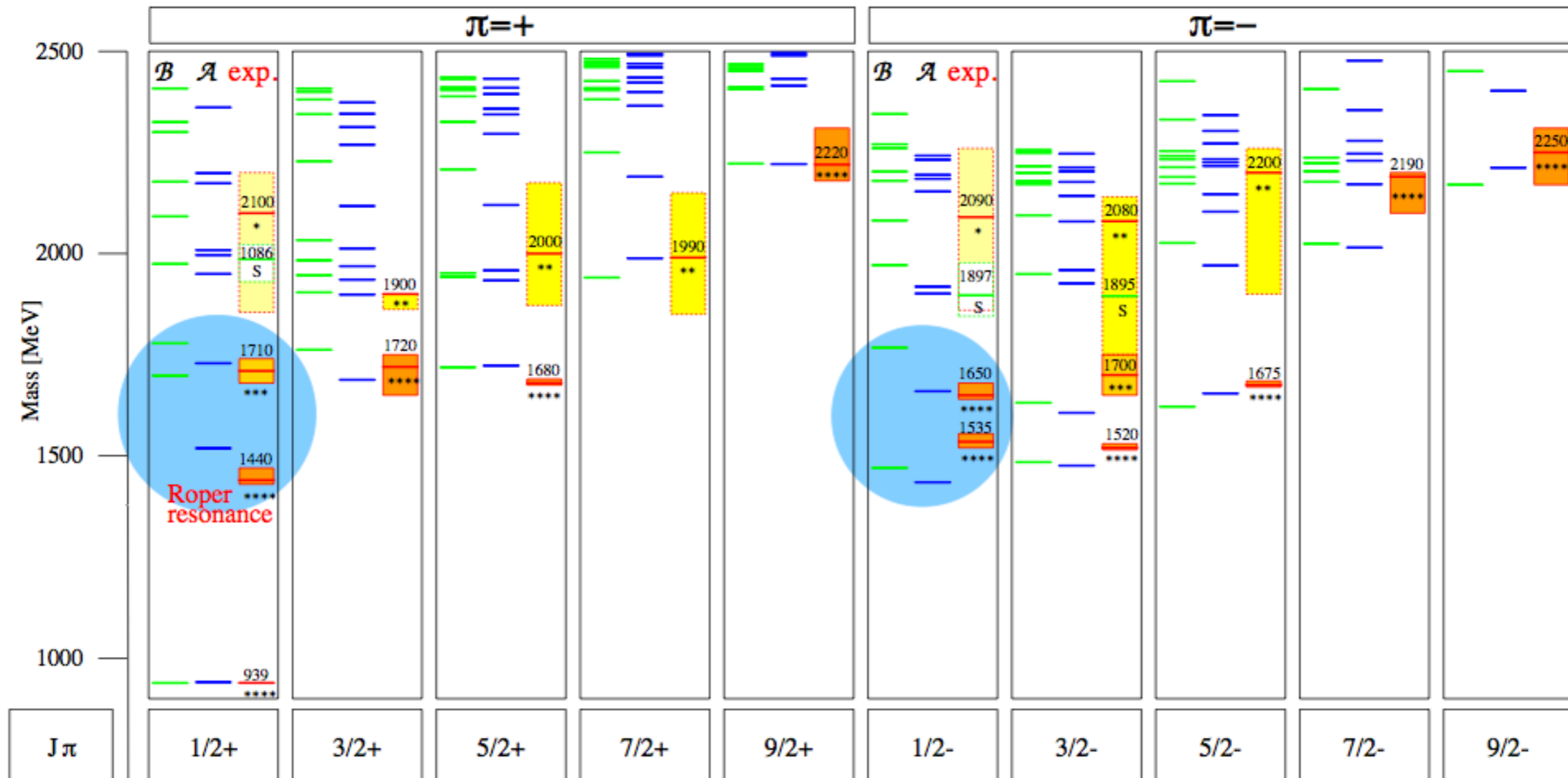

Loring, Metsch, Petry, EPJA 10 (2001) 395

- ‘missing resonances’ - three-body vs. quark-diquark

- level ordering: $N_{\frac{1}{2}}$ vs. $\Lambda_{\frac{1}{2}}$

Vacuum: Baryons from BSEs

BSE for baryons (derived from equation of motion for G)

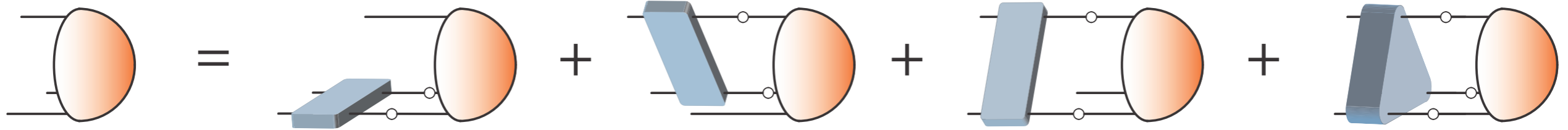

Faddeev equation (no three-body forces)

Diquark-quark

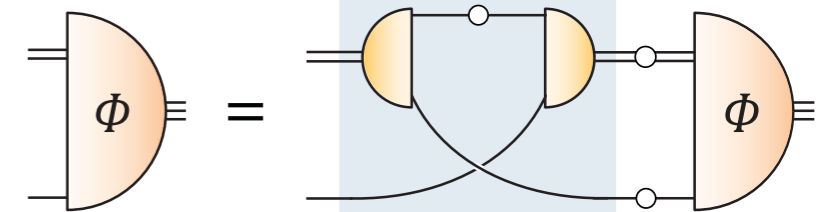
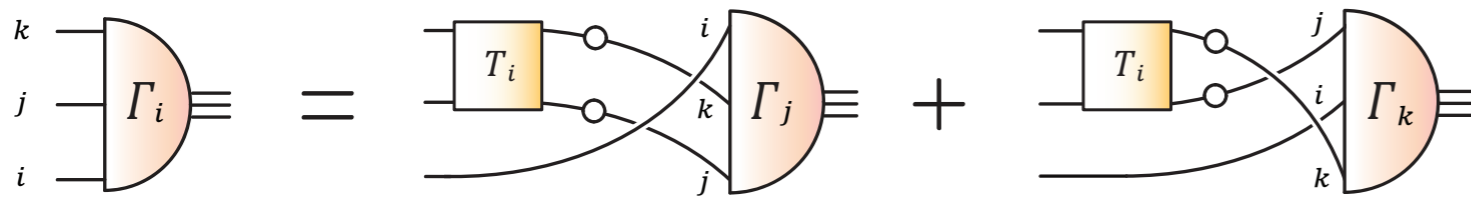

Vacuum: Baryons from BSEs

BSE for baryons (derived from equation of motion for G)

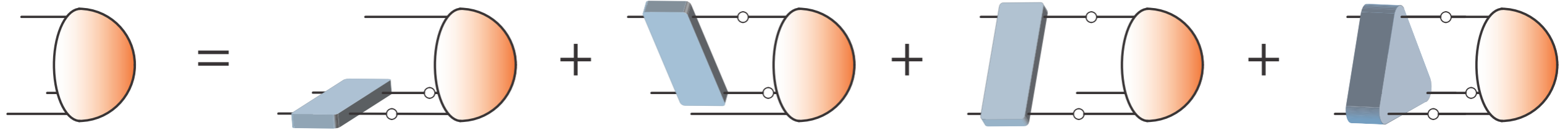

Faddeev equation (no three-body forces)

Diquark-quark

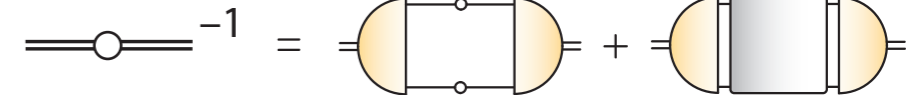
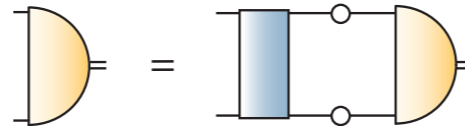
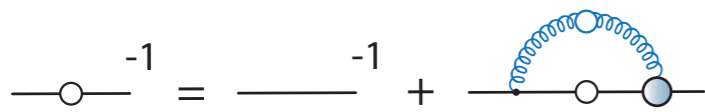
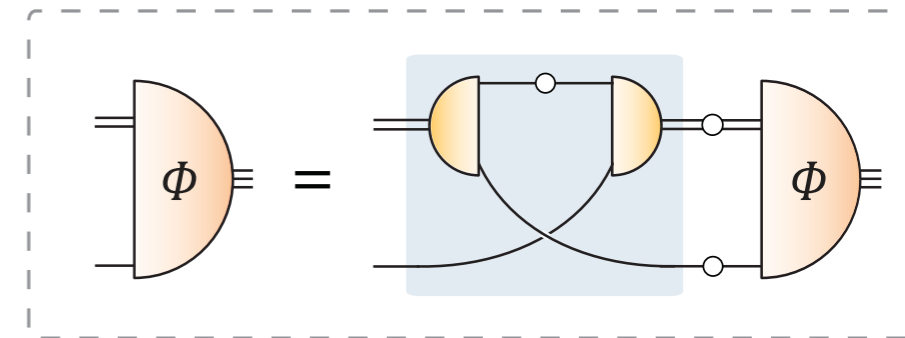
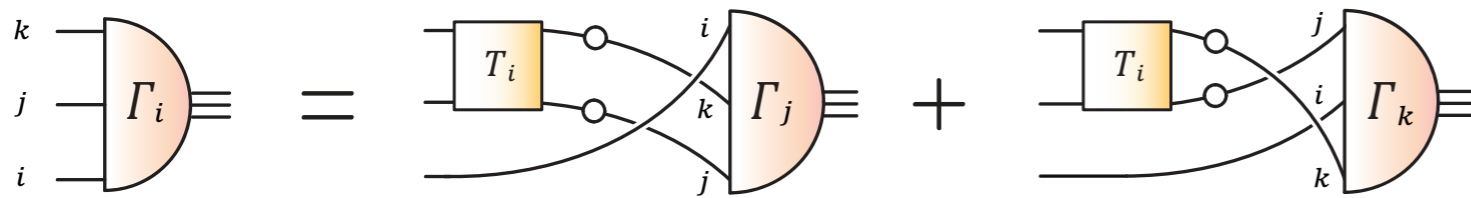

Vacuum: Baryons from BSEs

BSE for baryons (derived from equation of motion for G)

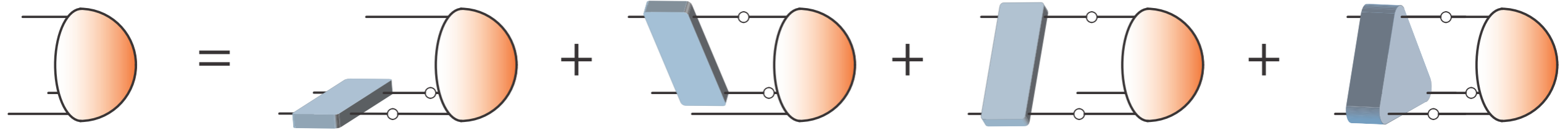

Faddeev equation (no three-body forces)

Diquark-quark

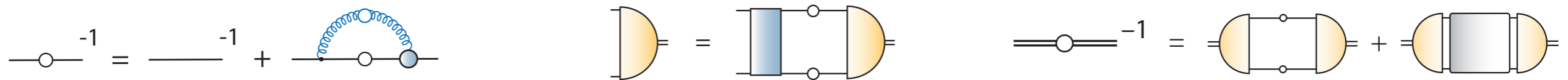
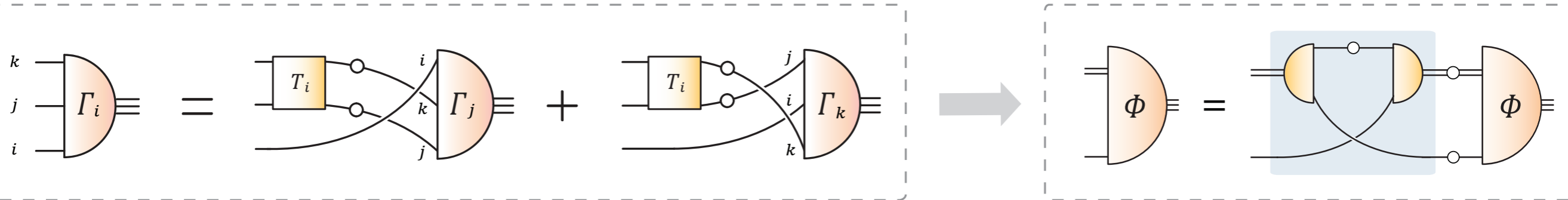

● **Input: Non-perturbative quark, quark-gluon interaction (RL)**

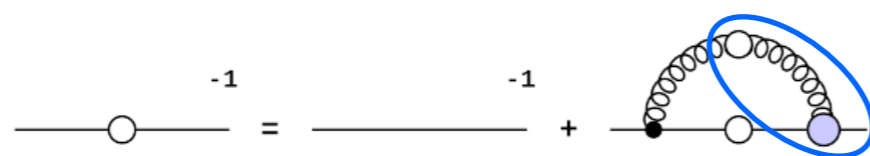

$$\alpha(k^2) = \pi\eta^7 \left(\frac{k^2}{\Lambda^2} \right) e^{-\eta^2 \left(\frac{k^2}{\Lambda^2} \right)} + \alpha_{UV}(k^2)$$

Baryon effects onto quark I

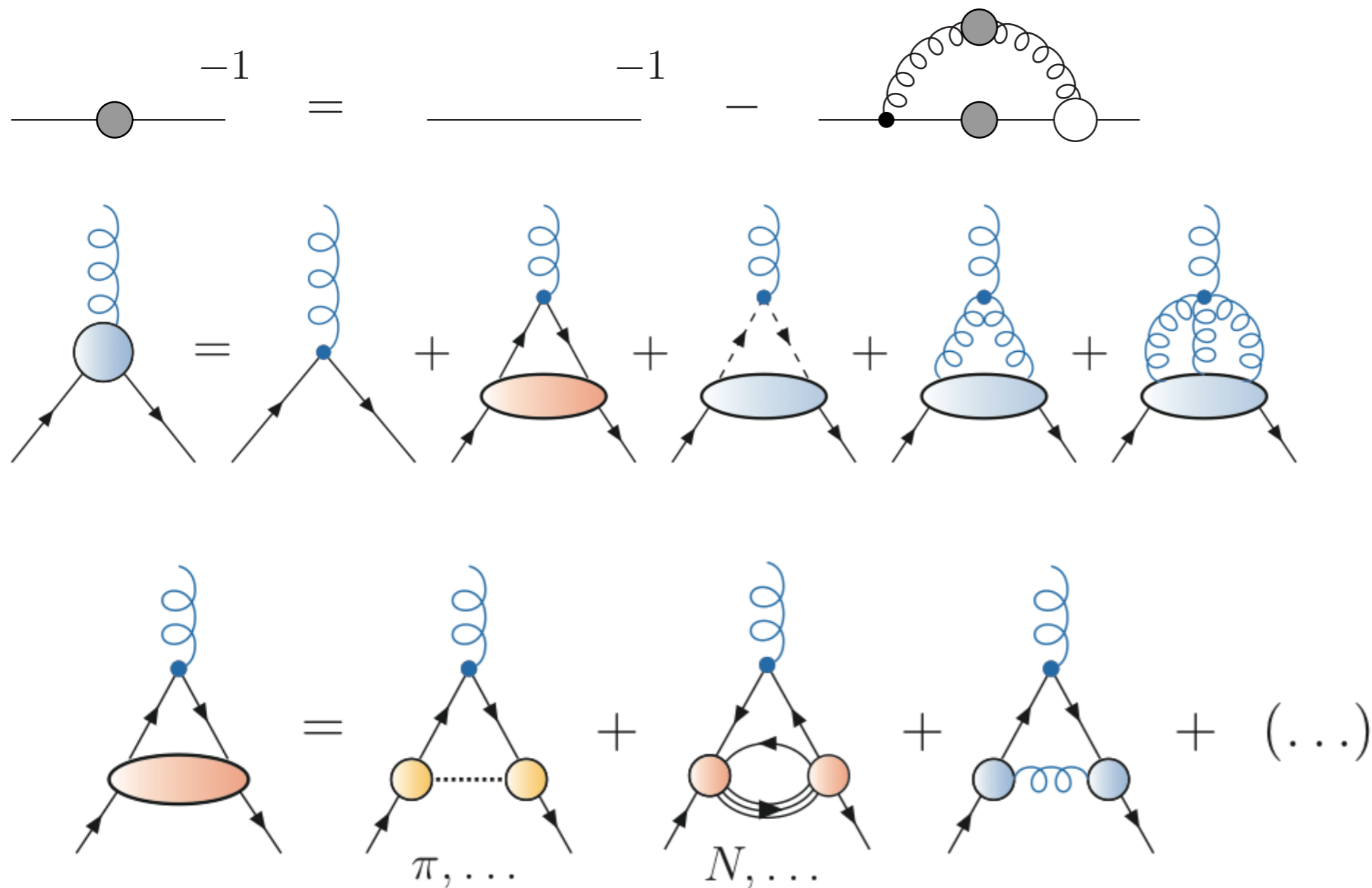

- ‘Off-shell baryons’ do affect quark condensate...

Vacuum: DSE/Faddeev landscape

	Quark-diquark			Three-quark		
	Contact interaction	QCD-based model	DSE (RL)	RL	bRL	bRL + 3q
N, Δ masses	✓	✓	✓	✓	✓	...
N, Δ em. FFs	✓	✓	✓	✓		
$N \rightarrow \Delta \gamma$	✓	✓	✓	...		
Roper	✓	✓		...		
$N \rightarrow N^* \gamma$	✓	✓		...		
$N^*(1535), \dots$	
$N \rightarrow N^* \gamma$				

Roberts et al

Oettel, Alkofer
Roberts, Bloch
Segovia et al.

Eichmann, Alkofer
Nicmorus, Krassnigg

Eichmann, Alkofer
Sanchis-Alepuz, CF

Sanchis-Alepuz, CF
Williams

Eichmann, N*-Workshop, Trento 2015

Vacuum: DSE/Faddeev landscape

	Quark-diquark			Three-quark		
	Contact interaction	QCD-based model	DSE (RL)	RL	bRL	bRL + 3q
N, Δ masses	✓	✓	✓	✓	✓	...
N, Δ em. FFs	✓	✓	✓	✓		
$N \rightarrow \Delta \gamma$	✓	✓	✓	...		
Roper	✓	✓		...		
$N \rightarrow N^* \gamma$	✓	✓		...		
$N^*(1535), \dots$	
$N \rightarrow N^* \gamma$		

Roberts et al
 Oettel, Alkofer
Roberts, Bloch
Segovia et al.
 Eichmann, Alkofer
Nicmorus, Krassnigg
 Eichmann, Alkofer
Sanchis-Alepuz, CF
 Sanchis-Alepuz, CF
Williams

Eichmann, N*-Workshop, Trento 2015

Approximation for Quark-Gluon interaction

- T,μ,m-dependent vertex:

Abelian WTI

$$\Gamma_\nu(q, k, p) = \tilde{Z}_3 \left(\delta_{4\nu} \gamma_4 \frac{C(k) + C(p)}{2} + \delta_{j\nu} \gamma_j \frac{A(k) + A(p)}{2} \right) \times$$

$$\times \left(\frac{d_1}{d_2 + q^2} + \frac{q^2}{\Lambda^2 + q^2} \left(\frac{\beta_0 \alpha(\mu) \ln[q^2 / \Lambda^2 + 1]}{4\pi} \right)^{2\delta} \right)$$

perturbation theory

Infrared ansatz:

- d2 fixed to match gluon input
- d1 fixed via quark condensate (see later)
- correct UV (quant.) and IR-behavior (qual.)

CF, Pawłowski, PRD 80 (2009) 025023

Mitter, Pawłowski and Strodthoff, PRD 91 (2015) 054035

Williams, Fischer, Heupel, PRD 93 (2016) 034026

DSE/Faddeev landscape ($T=\mu=0$)

	Quark-diquark			Three-quark		
	Contact interaction	QCD-based model	DSE (RL)	RL	bRL	bRL + 3q
N, Δ masses	✓	✓	✓	✓	✓	...
N, Δ em. FFs	✓	✓	✓	✓		
$N \rightarrow \Delta \gamma$	✓	✓	✓	...		
Roper	✓	✓		...		
$N \rightarrow N^* \gamma$	✓	✓		...		
$N^*(1535), \dots$	
$N \rightarrow N^* \gamma$				

Roberts et al

Oettel, Alkofer
Roberts, Bloch
Segovia et al.

Eichmann, Alkofer
Nicmorus, Krassnigg

Eichmann, Alkofer
Sanchis-Alepuz, CF

Sanchis-Alepuz, CF
Williams

Eichmann, N*-Workshop, Trento 2015

DSE/Faddeev landscape ($T=\mu=0$)

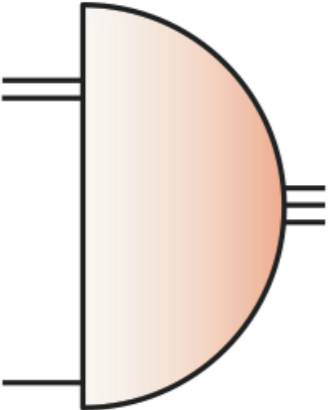
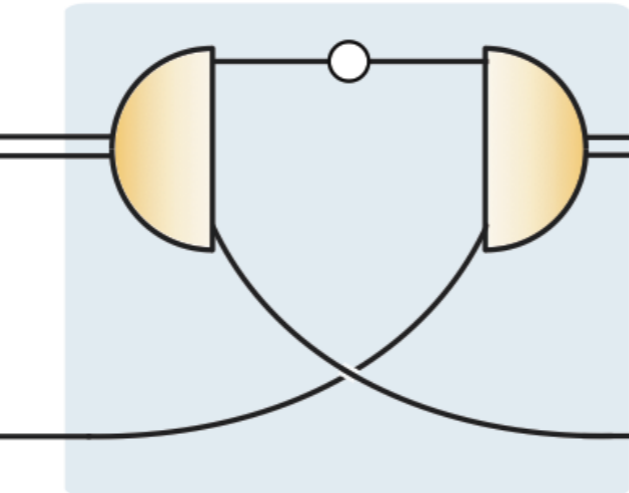
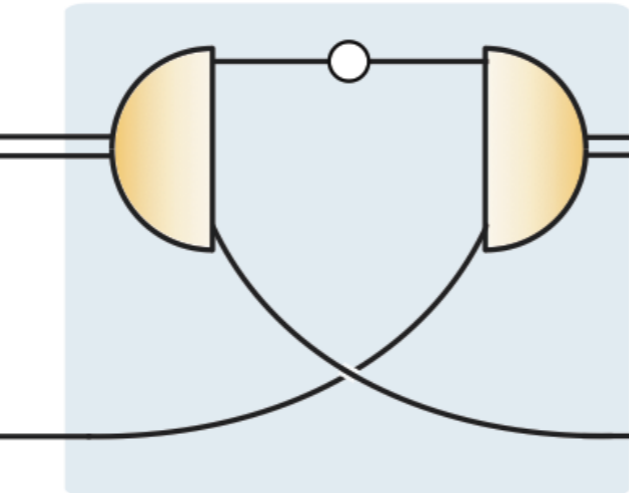
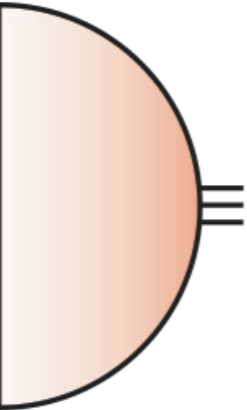
	Contact interaction	Quark-diquark QCD-based model	DSE (RL)	Three-quark RL	bRL	bRL + 3q
N, Δ N, Δ $N \rightarrow \dots$ Roper $N \rightarrow \dots$					✓	...
$N^*(1535), \dots$ $N \rightarrow N^* \gamma$
	Roberts et al	Oettel, Alkofer Roberts, Bloch Segovia et al.	Eichmann, Alkofer Nicmorus, Krassnigg	Eichmann, Alkofer Sanchis-Alepuz, CF	Sanchis-Alepuz, CF Williams	

Eichmann, N*-Workshop, Trento 2015

DSE/Faddeev landscape ($T=\mu=0$)

	Quark-diquark			Three-quark		
	Contact interaction	QCD-based model	DSE (RL)	RL	bRL	bRL + 3q
N, Δ masses	✓	✓	✓	✓	✓	...
N, Δ em. FFs	✓	✓	✓	✓		
$N \rightarrow \Delta \gamma$	✓	✓	✓	...		
Roper	✓	✓		...		
$N \rightarrow N^* \gamma$	✓	✓		...		
$N^*(1535), \dots$	
$N \rightarrow N^* \gamma$				

Roberts et al

Oettel, Alkofer
Roberts, Bloch
Segovia et al.

Eichmann, Alkofer
Nicmorus, Krassnigg

Eichmann, Alkofer
Sanchis-Alepuz, CF

Sanchis-Alepuz, CF
Williams

Eichmann, N*-Workshop, Trento 2015

DSE/Faddeev landscape ($T=\mu=0$)

	Quark-diquark			Three-quark		
	Contact interaction	QCD-based model	DSE (RL)	RL	bRL	bRL + 3q
N, Δ masses	✓	✓	✓	✓	✓	...
N, Δ em. FFs	✓	✓	✓	✓		
$N \rightarrow \Delta \gamma$	✓	✓	✓	...		
Roper	✓	✓		...		
$N \rightarrow N^* \gamma$	✓	✓		...		
$N^*(1535), \dots$	
$N \rightarrow N^* \gamma$				
	Roberts et al	Oettel, Alkofer Roberts, Bloch Segovia et al.	Eichmann, Alkofer Nicmorus, Krassnigg	Eichmann, Alkofer Sanchis-Alepuz, CF	Sanchis-Alepuz, CF Williams	

Eichmann, N*-Workshop, Trento 2015