

TOSHIBA

OWNER'S MANUAL

DATA PROJECTOR

TDP-TW300

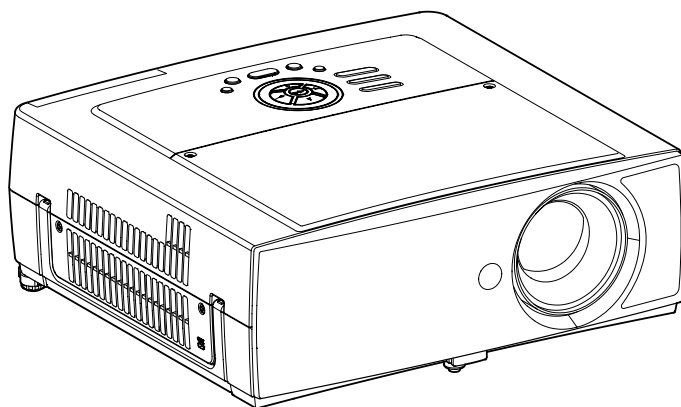

Before Using

Preparations

Operations

Maintenance

Others

SAFETY PRECAUTIONS



The lightning flash with arrowhead symbol, within an equilateral triangle, is intended to alert the user to the presence of uninsulated "dangerous voltage" within the product's enclosure that may be of sufficient magnitude to constitute a risk of electric shock to persons.



The exclamation point within an equilateral triangle is intended to alert the user to the presence of important operating and maintenance (servicing) instructions in the literature accompanying the appliance.

WARNING: TO REDUCE THE RISK OF FIRE OR ELECTRIC SHOCK, DO NOT EXPOSE THIS APPLIANCE TO RAIN OR MOISTURE. DANGEROUS HIGH VOLTAGES ARE PRESENT INSIDE THE ENCLOSURE. DO NOT OPEN THE CABINET. REFER SERVICING TO QUALIFIED PERSONNEL ONLY.

WARNING: Handling the cord on this product or cords associated with accessories sold with this product, will expose you to lead, a chemical known to the State of California to cause birth defects or other reproductive harm. ***Wash hands after handling.***

USA only

WARNING: This [product] contains mercury. Disposal of mercury may be regulated due to environmental considerations. For disposal or recycling information, please contact your local authorities or the Electronic Industries Alliance: www.eiae.org.

USA only

MODEL NAME: TDP-TW300

FCC Radio Frequency Interference Statement

Note: This equipment has been tested and found to comply with the limits for a Class A digital device, pursuant to part 15 of the FCC Rules. These limits are designed to provide reasonable protection against harmful interference when the equipment is operated in a commercial environment. This equipment generates, uses, and can radiates radio frequency energy and, if not installed and used in accordance with the instruction manual, may cause harmful interference to radio communications. Operation of this equipment in a residential area is likely to cause harmful interference in which case the user will be required to correct the interference at his own expense.

USA only

WARNING: Changes or modifications made to this equipment, not expressly approved by Toshiba, or parties authorized by Toshiba, could void the user's authority to operate the equipment.

USA only

Notice: This Class A digital apparatus complies with Canadian ICES-003. Cet appareil numérique de la classe A est conforme à la norme NMB-003 du Canada.

CANADA only

WARNING: This is a Class A product. In a domestic environment this product may cause radio interference in which case the user may be required to take adequate measures.

IMPORTANT SAFETY INSTRUCTIONS

CAUTION: PLEASE READ AND OBSERVE ALL WARNINGS AND INSTRUCTIONS GIVEN IN THIS OWNER'S MANUAL AND THOSE MARKED ON THE UNIT. RETAIN THIS BOOKLET FOR FUTURE REFERENCE.

This unit is fully transistorized and does not contain any parts that can be repaired by the user.

DO NOT REMOVE THE CABINET COVER, OR YOU MAY BE EXPOSED TO DANGEROUS VOLTAGE. REFER SERVICING TO QUALIFIED SERVICE PERSONNEL ONLY.

1. Read Owner's Manual

After unpacking this product, read the owner's manual carefully, and follow all the operating and other instructions.

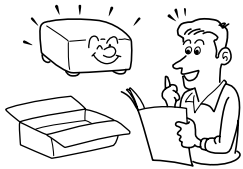

2. Power Sources

This product should be operated only from the type of power source which does not exceed the voltage range specified on the rating label and the power cord. If you are not sure of the type of power supply to your home, consult your product dealer or local power company.



3. Source of Light

Do not look into the lens while the lamp is on. The strong light from the lamp may cause damage to your eyes or sight.

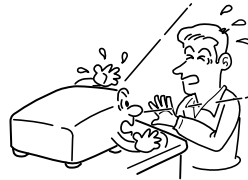

4. Ventilation

Openings in the cabinet are provided for ventilation and to ensure reliable operation of the product and to protect it from overheating, and these openings must not be blocked or covered. The openings should never be blocked by placing the product on a bed, sofa, rug or other similar surface. This product should not be placed in a built-in installation such as a bookcase or rack unless proper ventilation is provided.



5. Heat

The product should be situated away from heat sources such as radiators, heat registers, stoves, or other products (including amplifiers) that produce heat.

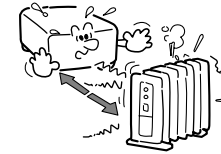

6. Water and Moisture

Do not use this product near water. - for example, near a bath tub, wash bowl, kitchen sink, or laundry tub; in a wet basement; or near a swimming pool and the like.

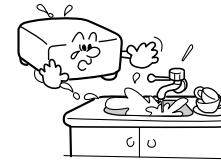

7. Cleaning

Unplug this product from the wall outlet before cleaning. Do not use liquid cleaners or aerosol cleaners. Use a soft cloth for cleaning.

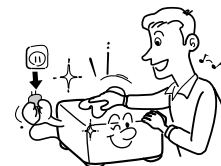

8. Power-Cord Protection

Power-supply cords should be routed so that they are not likely to be walked on or pinched by items placed upon or against them, paying particular attention to cords at plugs, convenience receptacles, and the point where they exit from the product.



9. Overloading

Do not overload wall outlets; to reduce the risk of electric shock, do not use the polarized plug with an extension cord, receptacle, or other outlet unless the blades can be inserted completely with three-wire grounding type to prevent blade exposure. As this can result in a risk of fire or electric shock.



IMPORTANT SAFETY INSTRUCTIONS (Continued)

10. Lightning storms

For added protection for this product during storm, or when it is left unattended and unused for long periods of time, unplug it from the wall outlet. This will prevent damage to the product due to lightning and power-line surges. However, while it is thundering or lightning, do not touch the apparatus and any connected cable and/or equipment. This will prevent you from receiving the electric shock by an electric surge.

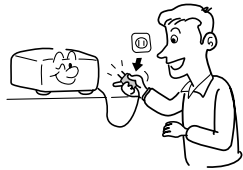

11. Object and Liquid Entry

Never push objects of any kind into this product through openings as they may touch dangerous voltage points or short-out parts that could result in a fire or electric shock. Never spill liquid of any kind on the product.



12. Do not place the product vertically

Do not use the product in the upright position to project the pictures at the ceiling, or any other vertical positions. It may fall down and dangerous.

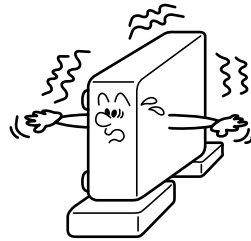

13. Stack Inhibited

Do not stack other equipment on this product or do not place this product on the other equipment. Top and bottom plates of this product develops heat and may give some undesirable damage to other unit.



14. Attachments

Do not use attachments not recommended by the product manufacturer as they may cause hazards.

15. Accessories

Do not place this product on an unstable cart, stand, tripod, bracket, or table. The product may fall, causing serious injury to a child or adult, and serious damage to the product. A product and cart combination should be moved with care. Quick stops, excessive force, and uneven surfaces may cause the product and cart combination to overturn.



16. Damage Requiring Service

Unplug this product from the wall outlet and refer servicing to qualified service personnel under the following conditions:

- When the power-supply cord or plug is damaged.
- If liquid has been spilled, or objects have fallen into the product.
- If the product has been exposed to rain or water.
- If the product does not operate normally by following the operating instructions. Adjust only those controls that are covered by the operating instructions as an improper adjustment of other controls may result in damage and will often require extensive work by a qualified technician to restore the product to its normal operation.

- If the product has been dropped or damaged in any way (If the cabinet should break, please handle with care to avoid injury) .
- When the product exhibits a distinct change in performance - this indicates a need for service.

17. If glass components, including lens and lamp, should break, contact your dealer for repair service.

This product incorporates glass components, including a lens and a lamp. If such parts should break, please handle with care to avoid injury and contact your dealer for repair service. The broken pieces of glass may cause to injury. In the unlikely event of the lamp rupturing, thoroughly clean the area around the projector and discard any edible items placed in that area.

18. Servicing

Do not attempt to service this product yourself as opening or removing covers may expose you to dangerous voltage or other hazards. Refer all servicing to qualified service personnel.



IMPORTANT SAFETY INSTRUCTIONS (Continued)

19. Replacement Parts

When replacement parts are required, be sure the service technician has used replacement parts specified by the manufacturer or have the same characteristics as the original part. Unauthorized substitutions may result in fire, electric shock, or other hazards. (Replacement of the lamp only should be made by users.)

20. Safety Check

Upon completion of any service or repairs to this product, ask the service technician to perform safety checks to determine that the product is in proper operating condition.

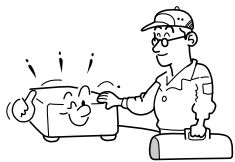

21. Do not leave thermal-paper documents or easily deformed items on top of the unit or near the air exhaust for long periods of time.

The heat from the unit could erase the information on the thermal paper, or cause deformation or warping.

22. Do not use the product in a closed installation state.

Do not place the product in a box or in any other closed installation state. Otherwise it may overheat. This could result in a risk of fire.

23. Do not look into the laser light source of the remote control or direct the laser pointer toward a person or a mirror.

The laser beam may cause damage to the eyes or sight.

24. When using a wireless LAN PC card:

- Do not use near people with heart pacemakers
- Do not use near electronic medical equipment, or in hospitals or other medical institutions
- Do not use inside aircraft or in places where the wireless LAN card could interfere with electromagnetic signals.

The electromagnetic interference could cause a malfunction, resulting in an accident.

25. If the use of a wireless LAN PC card interferes with another device's electromagnetic signals, cease use immediately.

The electromagnetic interference could cause a malfunction, resulting in an accident.

POWER SUPPLY CORD SELECTION

If your line voltage is 220 to 240V, use one of the following types of cable.

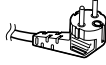
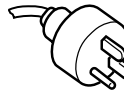
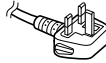
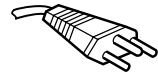
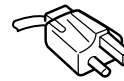
Plug configuration	Plug type	Line voltage	Plug configuration	Plug type	Line voltage
	EURO	220 – 240V		Australian 240V 10A	200 – 240V
	UK	220 – 240V		Switzerland 240V 6A	200 – 240V
				North American 240V 15A	200 – 240V

Use a 5A fuse which is approved by ASTA or BSI to BS1362. Always replace the fuse cover after changing the fuse.

IMPORTANT PRECAUTIONS

Save Original Packing Materials

The original shipping carton and packing materials will come in handy if you ever have to ship your projector. For maximum protection, repack the set as it was originally packed at the factory.

Moisture Condensation

Never operate this unit immediately after moving it from a cold location to a warm location. When the unit is exposed to such a change in temperature, moisture may condense on the lens and the crucial internal parts. To prevent the unit from possible damage, do not use the unit for at least 2 hours when there is an extreme or sudden change in temperature.

Place and Manner of Installation

- Do not place in hot locations, such as near heating equipment. Doing so could cause malfunction, and shorten the life of the projector.
- Avoid locations with oil or cigarette smoke. Doing so will dirty the optical parts, shortening their lives, and darkening the screen.
- Do not use this product in the upright position or tilt it up or down by more than 20° from level. Doing so may cause a failure or shorten the life of the product.
- Using this instrument near a TV or radio may cause interference to the images or audio sound. If this happens, move it away from the TV or radio.
- Moving the projector from a low-temperature room to a high-temperature room may cause condensation on the lens or internal parts in the instrument. If you continue to use it in that situation, the malfunction may result. Ensure to wait until the condensation naturally disappears.
- In a high altitude location where air is thin, cooling efficiency is reduced so use the projector with [Fan mode] set to [High]. [p.45](#)

IMPORTANT PRECAUTIONS (Continued)

Avoid Volatile Liquid

Do not use volatile liquids, such as an insect spray, near the unit. Do not leave rubber or plastic products touching the unit for a long time. They will leave marks on the finish. If cleaning with a chemically saturated cloth, be sure to follow the product's precautions.

Wireless LAN PC Card

- Do not connect the supplied wireless LAN PC card to devices other than this unit. Doing so could cause malfunction.
- To protect the PC card from static electricity, touch some nearby metal, such as a doorknob or aluminum window frame, before touching the PC card, to rid your body of static electricity.
- This PC card is a radio product. Concerning the regulations applied in each country/area, please refer to "Information to the user" supplied.

EXEMPTION CLAUSES

- Toshiba Corporation bears no responsibility in the case of damages arising from natural disaster such as earthquakes, lightning, etc., fire not liable to Toshiba Corporation, acts by third parties, other accidents, or use under abnormal conditions including erroneous or improper operation and other problems.
- Toshiba Corporation bears no responsibility for incidental damages (lost profit, work interruption, corruption or loss of the memory contents, etc.) arising from the use of or the inability to use this unit.
- Toshiba Corporation accepts no liability whatsoever for any damages arising from not having followed the descriptions in this Instruction Manual.
- Toshiba Corporation accepts no liability whatsoever for any damages arising from malfunctions arising from combination with equipment or software that is not related to Toshiba Corporation.
- Toshiba bears no responsibility for information being intercepted or leaked due to the use of a wireless LAN, or any damages therefore.

In the spaces provided below, record the Model and Serial No. located at the bottom of your projector.

Model No. _____ Serial No. _____

Retain this information for future reference.

OTHER CAUTIONS AND INFORMATIONS

Copyrights

Showing or transmitting commercial imaging software or broadcast or cable-broad casting programs with the purpose of other than the personal and private viewing, including modifying images using the freeze, resize, PIP, or SPLIT screen functions, or displaying with the varying aspect ratio of the images, could violate the direct or indirect copyrights of the imaging software or broadcast program, etc., if done without first consulting with the copyright holder. For this reason, please take appropriate measures before performing one of the actions listed above, including obtaining a license from the copyright holder.

Disposal

This product contains substances which are harmful to humans and the environment.

- The lamp contains mercury.

Please dispose of this product or used lamps in accordance with local regulations.

Trademarks

- VGA, SVGA, XGA, SXGA, UXGA are trademarks or registered trademarks of International Business Machines Corporation.
- Digital Light Processing, Digital Micromirror Device and DMD are trademarks of Texas Instruments.
- Macintosh is a registered trademark of Apple Computer, Inc.
- Windows is a registered trademark of Microsoft Corporation in the U.S. and other countries.
- Adobe is a registered trademark and Acrobat Reader is a trademark of Adobe Systems Incorporated.

Notational Conventions Used in This Manual

- References to pages with related information are annotated as follows.
For example, if making a reference to page 36: [p.36](#)
- The illustrations in this document are for reference purposes only and may not reflect your package exactly.

REMOTE CONTROL BATTERIES

Caution

- Never throw batteries into a fire.
- Using the batteries improperly may cause them to explode or leak and lead to burn or injury. If battery-leaking fluid contacts skin, wash the fluid off immediately with clean water and consult a doctor. If the fluid is spilt on an instrument, avoid contact and wipe it off using tissue paper. (Dispose of the used tissue paper as flammable garbage after moistening with water.)

Notes

- Be sure to use AAA (LR03) size batteries.
- Dispose of batteries in a designated disposal area.
- Attention should be drawn to the environmental aspects of battery disposal.
- Do not mix different battery types or combine used batteries with new ones.
- If the remote control does not operate correctly, or if the operating range becomes reduced, replace both batteries with new ones.
- If the batteries are dead or if you will not be using the remote control for a long time, remove the batteries to prevent battery acid from leaking into the battery compartment.

CONTENTS

Before Using

SAFETY PRECAUTIONS	2
IMPORTANT SAFETY INSTRUCTIONS	4
POWER SUPPLY CORD SELECTION	9
IMPORTANT PRECAUTIONS	9
EXEMPTION CLAUSES	10
OTHER CAUTIONS AND INFORMATIONS	11
REMOTE CONTROL BATTERIES	11
CONTENTS	12

Preparations

Checking the package contents	14
Names of each part on the main unit	15
Names of each part on the control panel and remote control	16
Label locations	18
Parts on the rear panel	18
Preparing and using the remote control	20
Operating a computer using the remote control	21
Placement	22
Connection	24

Operations

Turning the power on and off	26
Basic operations	28
Using handy features	30
Easy setup	30
Using auto setting	30
Correcting the keystone distortion	31
Resizing image	32
Cutting off the picture and sound temporarily (Mute)	33
Changing picture mode	33
Changing screen size	33
Freezing the image (Freeze)	33
Display a sub screen (PIP function)	34
Sub screen setting	34
Displaying two screens (SPLIT function)	35
SPLIT function setting	35
Screen combination of PIP and SPLIT functions	36
Password function	36
Using the menus	39
How to use the menus	39
The image adjustment menu	39
The display setting menu	41
The default setting menu	45
The control setting menu	46
How to use the PC card slot	49
How to use the USB terminal	50
Connecting USB memory	50

Disconnecting USB memory	50
Setting Wireless Utility	51
Functions	51
Communication mode	51
Caution when using the wireless LAN functions	52
Setup using the setting display (2)	53
Setting Wireless Utility	54
Computer settings	57
Projecting images stored in a memory PC card or USB memory	58
Memory PC cards	58
USB memories	59
Backing up data	59
JPEG files	59
Setting slideshow options	60
Playing a slide show from a thumbnail list	62
Checking the projector status	65
Status display	65
Installing the applications	66
Using the Wireless Utility	67
Displaying a computer's screen via the projector	67
Displaying a JPEG image saved on a computer via the projector	69
Config Free utility	70
Operating the projector	73
How to use the JPEG Conversion Tool	75
Launching the JPEG Conversion Tool	75
Converting an image file	75
Converting files created with Microsoft® PowerPoint®	76
Making a presentation with converted JPEG files	77
Creating a screen capture and converting it into a JPEG file	77
Setting up the projector using a Web browser	78
How to use the "Projector Configuration Tool"	78

Maintenance

About lamp	80
Lamp replacement	80
Lens and main unit cleaning	83

Others

Trouble indications	84
Before calling service personnel	85
Specifications	87
List of general specifications	87
Separately sold product	87
List of supported signals (RGB signals)	88
List of supported signals (Y/Pb/Pr signals)	89
List of supported signals (Video, S-Video signals)	89
Pin assignment of COMPUTER-2 & MONITOR terminals	89
Pin assignment of DVI-I terminal	90
CONTROL terminal	91

Checking the package contents

Please make sure that the following items are included in the box, along with the main unit. If any item is missing, please contact the store immediately where you purchased the product.

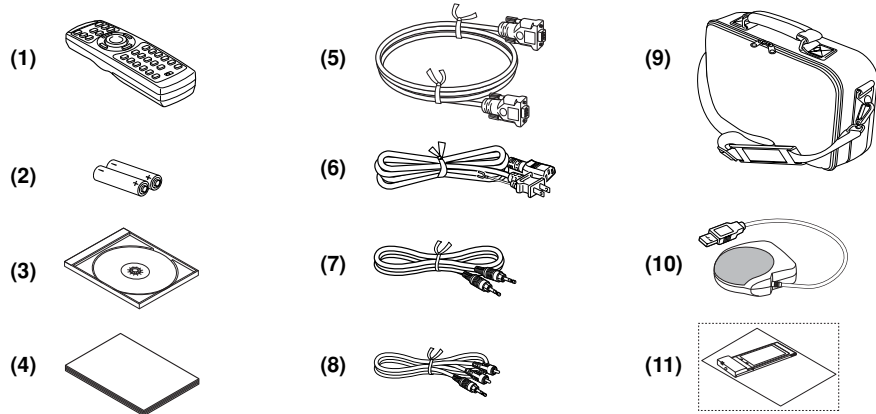

- (1) Remote control
- (2) LR03 (SIZE AAA) batteries for remote control (2)
- (3) CD-ROM
- (4) Owner's Manual
- (5) RGB cable (3m)
- (6) Power cord (See note)
- (7) Audio cable (for computer input)
- (8) Audio cable (for video input)
- (9) Carrying bag
- (10) Mouse remote control receiver
- (11) Wireless LAN PC card
 - "About the Wireless LAN PC Card"

Note
The shape and number of supplied power cords vary depending on the product destination.

◆The Supplied CD-ROM

The supplied CD-ROM contains the owner's manual including information not available for its simplified hardcopy, Owner's Manual (Getting Started), Acrobat® Reader™ to view the manual, and application software [p.65](#) to use the functions of the wireless LAN/PC card.

■ Installing Acrobat® Reader™

Windows®: Run the CD-ROM, select the **Reader/English** folder, and run **ar500enu.exe**. Follow the on-screen instructions.

Macintosh: Run the CD-ROM, select the **Reader/English** folder, and run **Reader Installer**. Follow the on-screen instructions to install the software.

■ Viewing the manual

Run the CD-ROM and double-click on **Start.pdf**. Acrobat® Reader™ launches, and the menu screen of the Owner's manual appears. Click on your language. The Owner's Manual cover and list of bookmarks appear. Click on a bookmark title to view that section of the manual. Click on [p.](#) to view a reference page with related information. See the Help menu for more information about Acrobat® Reader™.

Names of each part on the main unit

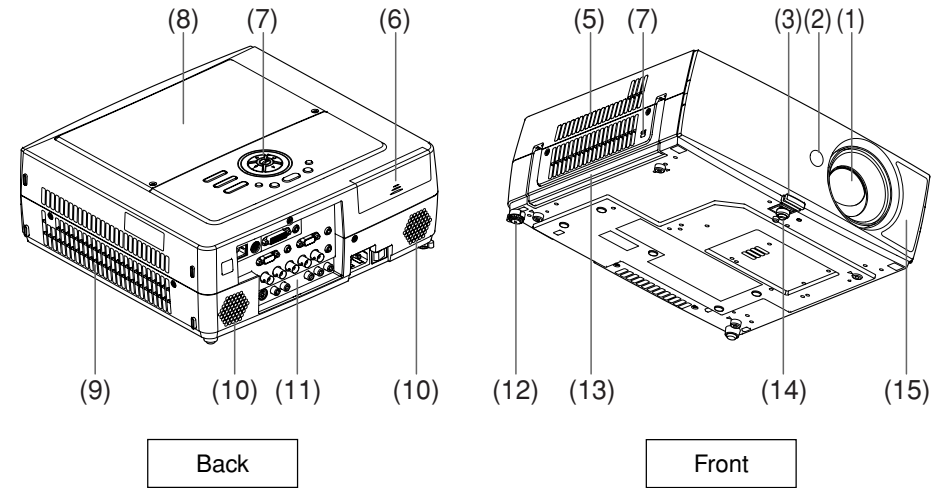

Name	: Function
(1) Lens	: Projects expanded image.
(2) Infrared remote sensor	: Senses commands from the remote control. p.20
(3) Foot adjuster release button	: Press to set up or stow the foot adjuster. p.29
(4) Antitheft lock hole	: Attach a safety cable or any other antitheft device.
(5) Air exhaust	: Expels air that has grown hot inside the projector.
(6) PC card slot cover	: Remove to mount/remove the PC card. p.23
(7) Control panel	: Operates the projector. p.16
(8) Lamp cover	: Remove to replace lamp. p.79
(9) Air intake	: Draws in air from outside the projector.
(10) Speaker	: Outputs audio sound.
(11) Rear panel	: Connects external devices. p.18
(12) Tilt adjuster	: Adjusts the projector's horizontal tilt. p.29
(13) Handle	: Hold to carry the projector.
(14) Foot adjuster	: Adjusts the vertical projection angle. p.29
(15) AF sensor	: 0 Used for Auto focus and Auto keystone functions.

Names of each part on the control panel and remote control

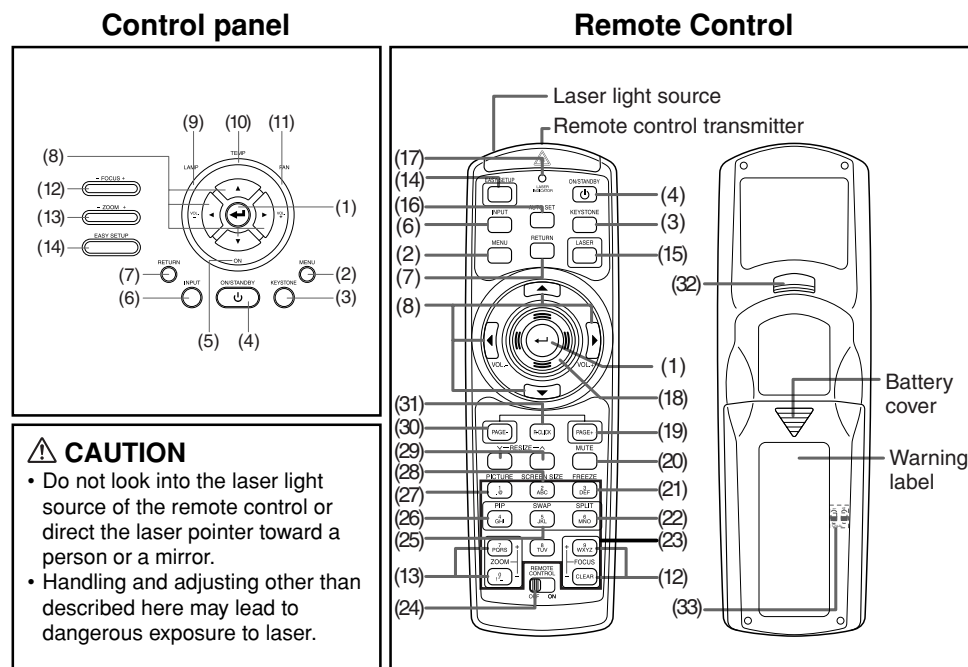

CAUTION

- Do not look into the laser light source of the remote control or direct the laser pointer toward a person or a mirror.
- Handling and adjusting other than described here may lead to dangerous exposure to laser.

Name : Main Function

Control panel

- (1) ENTER button : Accepts the selected mode.
- (2) MENU button : Displays menus. [p.38](#)
- (3) KEYSTONE button : Adjusts keystone distortion. [p.30](#)
- (4) ON/STANDBY button : Turns the power on/off (standby). [p.26](#)
- (5) ON/STANDBY indicator : Displays whether power is on or off. [p.26](#)
- (6) INPUT button : Selects input. [p.28](#)
- (7) RETURN button : Goes back one screen.
- (8) Selection button : Menu selections and adjustments, volume control, etc. [p.38](#)
- (9) LAMP indicator : Displays lamp mode. [p.27](#)
- (10) TEMP indicator : Lights when internal temperature too high. [p.82](#)
- (11) FAN indicator : Displays cooling fan mode. [p.82](#)
- (12) FOCUS button : Adjusts the screen focus.
- (13) ZOOM button : Adjusts the screen size.
- (14) EASY SETUP button : Performs auto-adjustment. [p.50](#)

Remote control

- (1) ENTER button : Accepts the selected mode.
- (2) MENU button : Displays menus. [p.38](#)
- (3) KEYSTONE button : Adjusts keystone distortion. [p.30](#)
- (4) ON/STANDBY button : Turns the power on/off (standby). [p.26](#)
- (6) INPUT button : Selects input. [p.28](#)

- | Name | Main Function |
|--|--|
| (7) RETURN button | : Goes back one screen. |
| (8) Selection button | : Menu selections and adjustments, volume control, etc. p.38 |
| (12) FOCUS button | : Adjusts the screen focus. |
| (13) ZOOM button | : Adjusts the screen size. |
| (14) EASY SETUP button | : Performs auto-adjustment. p.50 |
| (15) LASER button | : Shows a laser pointer. |
| (16) AUTO SET button | : Sets up analog input from computer. p.30 |
| (17) Laser indicator | : Lights when laser is on. |
| (18) Mouse control button | : Controls a mouse pointer. p.21 |
| (19) PAGE+ button | : Proceeds PowerPoint® slides. p.21 |
| (20) MUTE button | : Cuts off the picture and sound temporarily. p.32 |
| (21) FREEZE button | : Pauses image. p.33 |
| (22) SPLIT button | : Displays two screens. p.35 |
| (23) Ten-Key button | : Use as a ten-key pad with wired LAN, from which numbers and characters can be entered. p.47 |
| (24) Remote control ON/OFF switch | : Switches on/off the remote control. p.20 |
| (25) SWAP button | : Swaps the main screen and the sub screen in PIP mode, or swaps the two screens in SPLIT mode. p.34 |
| (26) PIP button | : Displays the sub screen. p.34 |
| (27) PICTURE button | : Changes image mode. p.33 |
| (28) SCREEN SIZE button | : Changes screen size. p.33 |
| (29) RESIZE button | : Enlarges image. p.31 |
| (30) PAGE- button | : Goes back PowerPoint® slides. p.21 |
| (31) R-CLICK button | : Functions as right-click of a mouse. p.21 |
| (32) L-CLICK button | : Functions as left-click of a mouse. p.21 |
| (33) Remote control code switch (inside the battery cover) | : Sets the code of remote control to that of the projector. p.45 |

Note

- For the remainder of this manual, buttons are referred to as follows:
 Selection buttons ⇒ ; ENTER button ⇒

Label locations

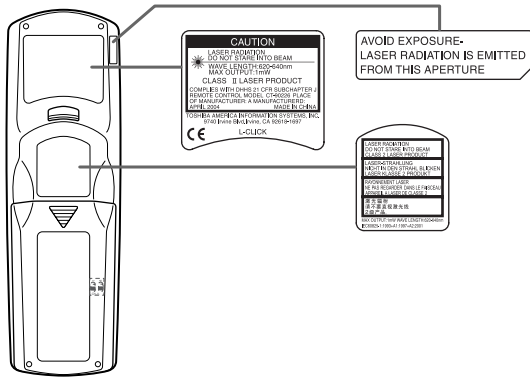

Caution – use of controls or adjustments or performance of procedures other than those specified herein may result in hazardous radiation exposure.

Parts on the rear panel

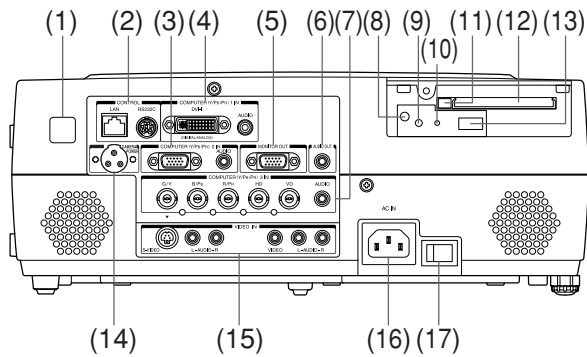

■ Removing the slot cover

Press on the circle (“O”) while sliding the cover in the direction of the arrow. The cover will come off.

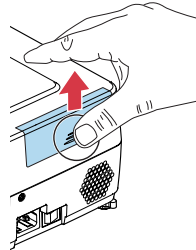

CAUTION

Do not carry the projector by having the slot cover part. Doing so may cause that cover to come off, resulting in the projector malfunction, injury or damage.

Name	Main Function
(1) Infrared remote sensor	: Senses commands from the remote control. p.20
(2) CONTROL terminal	: Connects a network cable. RS232C : When operating the projector via a computer, connect this to the controlling computer's RS-232C port. p.89
(3) COMPUTER (Y/Pb/Pr) 2 IN terminal	RGB : Input analog RGB signal from a computer or other source, or a component video signal (Y/Pb/Pr) from video equipment. AUDIO : Input audio signals.
(4) COMPUTER (Y/Pb/Pr) 1 IN terminal	DVI-I : Input analog or digital RGB signal from a computer, or a component video signal (Y/Pb/Pr) from video equipment. AUDIO : Input audio signals.
(5) MONITOR terminal	: Connect to a computer display, etc.
(6) AUDIO OUT terminal	: Outputs audio signals.
(7) COMPUTER (Y/Pb/Pr) 3 IN terminal	BNC : Input G/B/R/HD/VD signal from a computer, or a component video signal (Y/Pb/Pr) from video equipment. AUDIO : Input audio signals.
(8) CARD indicator	: Displays PC card's status. p.23
(9) UNMOUNT button	: Press before removing PC card. p.23
(10) RESET switch (inside depression)	: Press if CARD indicator turns red. p.23
(11) Eject button	: Press to remove PC card. p.23
(12) PC card slot	: Insert PC cards here. p.23
(13) USB terminal	: Connects a commercial USB memory. p.21
(14) CAMERA POWER terminal	: DC power supply terminal (+15 V). Reserved for future use.
(15) VIDEO IN terminal	S-VIDEO : Input S video signals from video equipment. AUDIO (L/R) : Input audio signals from video equipment. VIDEO : Input video signals from video equipment. AUDIO (L/R) : Input audio signals from video equipment.
(16) AC IN socket	: Connect the supplied power cord here.
(17) Main power switch	: AC power line ON (standby)/OFF.

Preparing and using the remote control

■ Loading dry-cell batteries into the remote control

① Remove the battery cover.

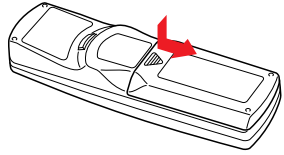

② Insert the dry-cell batteries.

Be sure to align the plus and minus ends of the batteries properly.

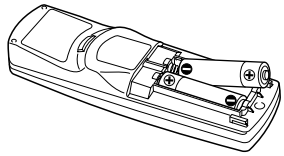

Two batteries (LR03, SIZE AAA) are used.

③ Replace the battery cover.

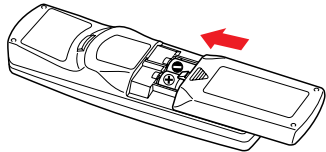

■ Dry-cell batteries

- Before using the batteries, be sure to observe the Safety Precautions described in previous pages.
- Remove batteries from remote control when not using for extended periods.
- If the remote control stops working, or if its range decreases, replace all the batteries with new ones.

■ The remote control

- Turn off the ON/OFF switch of the remote control when not in use or to store in baggage.
- The remote control may fail to operate if the infrared remote sensor is exposed to bright sunlight or fluorescent lighting.
- Do not drop or bang.
- Do not leave in hot or humid locations.
- Do not get wet or place on top of wet objects.
- Do not take apart.
- In rare cases, ambient conditions could impede the operation of the remote control. If this happens, point the remote control at the main unit again, and repeat the operation.

■ Operating the remote control

Turn on the ON/OFF switch of the remote control.

Point toward the projector's infrared remote sensor, and press a button on the remote control.

- Operating the projector from the front

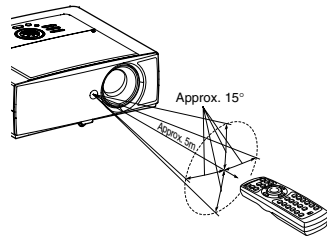

- Operating the projector from the rear

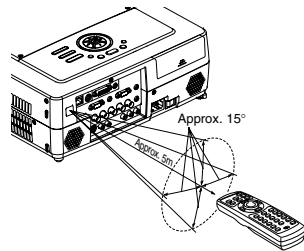

Operating a computer using the remote control

A computer can be operated using the projector's remote control. This function is available on any computer with the Windows 98/98SE, Windows Me, Windows 2000, or Windows XP OS, that is equipped with a USB port which can support USB1.1 (The mouse remote control receiver is also supported on OS 9 or OS X for the Macintosh). However, please note that Toshiba does not guarantee the operation of all computers.

① Connecting a computer

Connect the mouse remote control receiver (supplied) to a computer.

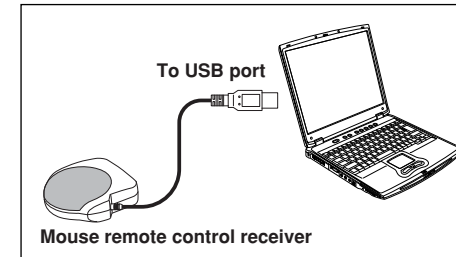

The remote control may fail to operate if the mouse remote control receiver is exposed to bright sunlight or fluorescent lighting.

In such a case, change position or direction of the mouse remote control receiver and retry.

② Operating a computer

Operate remote control's buttons towards the mouse remote control receiver.

● Moving the mouse pointer

Press the mouse control button in the direction you wish the mouse pointer to move, then press.

● To left click

Press the L-CLICK button.

● To right click

Press the R-CLICK button.

● To drag and drop

Holding down the L-CLICK button, move the mouse control button until the mouse pointer is over the desired location, then release the L-CLICK button.

● Using the computer's page up [↑] and down [↓] function

Press the PAGE+ and PAGE- buttons to switch PowerPoint® slides.

Remote Control Front

Remote Control Rear

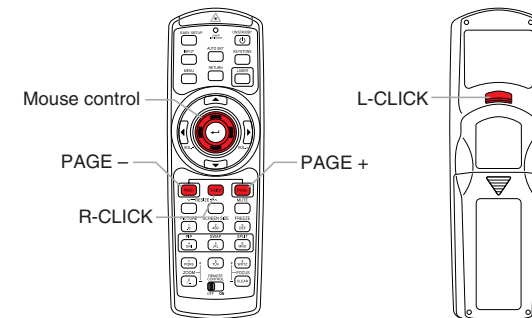

Placement

Placement Styles

As shown in the figures below, this device can be placed in 4 different styles. The factory setting is "floor-mounted front projection." Set the [Projection mode] in the Default setting menu [p.44](#), in accordance with your needs.

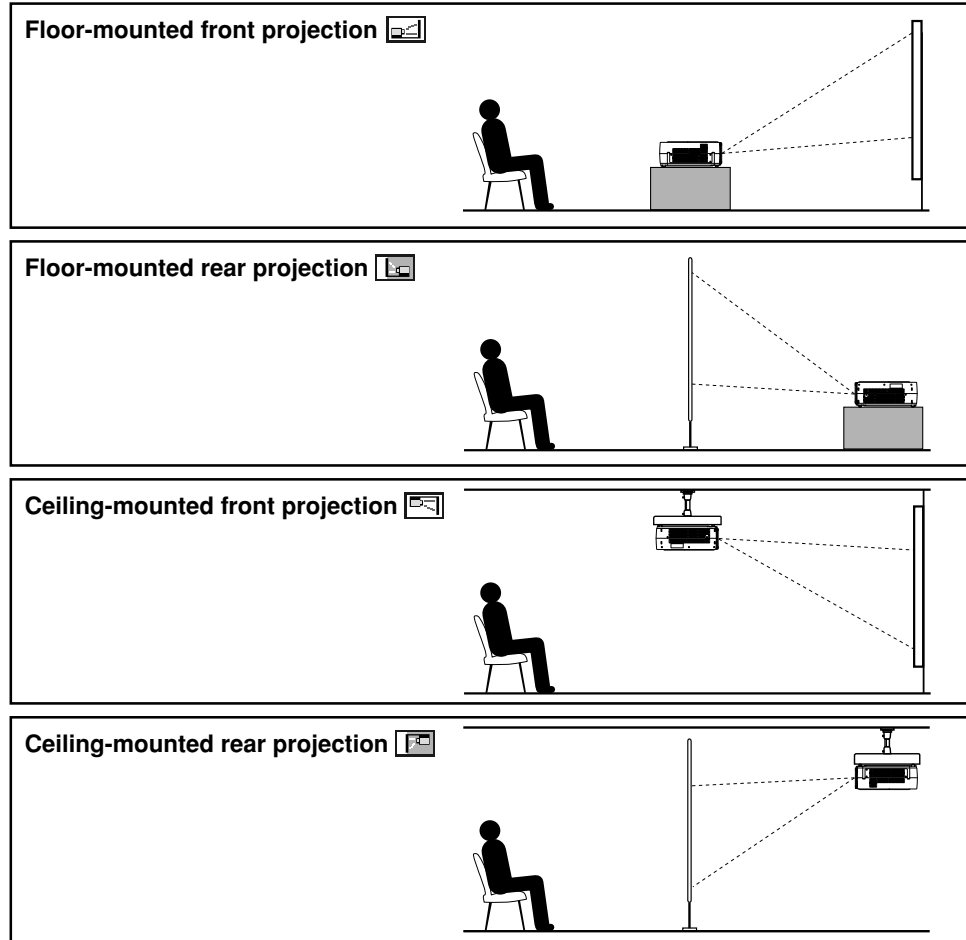

⚠ WARNING

- Always obey the instructions listed in IMPORTANT SAFETY INSTRUCTIONS when placing the unit. Attempting to clean/replace the lamp at a high site by yourself may cause you to drop down, thus resulting in injury.
- If you wish to mount the projector on the ceiling, be sure to ask your dealer to do so. Mounting the projector on a ceiling requires special ceiling brackets (sold separately) and specialized knowledge. Improper mounting could cause the projector to fall, resulting in an accident.
- If the projector is ceiling-mounted, install the breaker for turning off the power in case of anomaly. Let everyone involved with the use of the projector know that fact.

Projection Distance and Size

Use the figures, tables, and formulas below to determine the projection size and projection distance. (Projection sizes are approximate values for full-size picture with no keystone adjustment.)

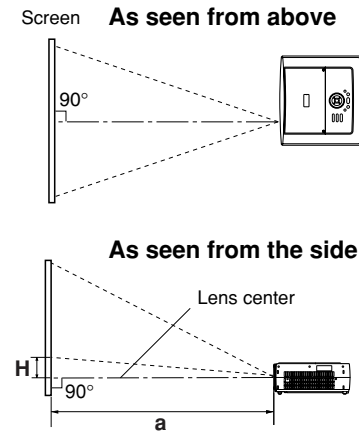

$$a \text{ (min length)} = \frac{\text{projection size (inches)} - 1.552}{32.929}$$

$$a \text{ (max length)} = \frac{\text{projection size (inches)} - 1.0087}{21.735}$$

projection size (inches)	projection distance a (m)		height (H) (cm)
	min length (zooming max)	max length (zooming min)	
33	—	1.17	6.8
40	1.17	1.79	8.2
60	1.77	2.71	12.3
80	2.38	3.63	16.5
100	2.99	4.55	20.6
150	4.51	6.85	30.9
200	6.03	9.16	41.1
250	7.54	11.46	51.4
300	9.06	13.76	61.7

a is the distance (m) between the lens and the screen, and corresponds to a range of 1.17 m to 13.76 m. **H** is the height from the image bottom to the center of the lens.

Connection

Before connection

- Read the owner's manual of the device you are connecting to the projector.
- Some types of computer cannot be used or connected to this projector.
Check for an RGB output terminal, supported signal [p.86](#), etc.
- Turn off the power of both devices before connecting.
- The figures are sample connections.

Connecting with computers

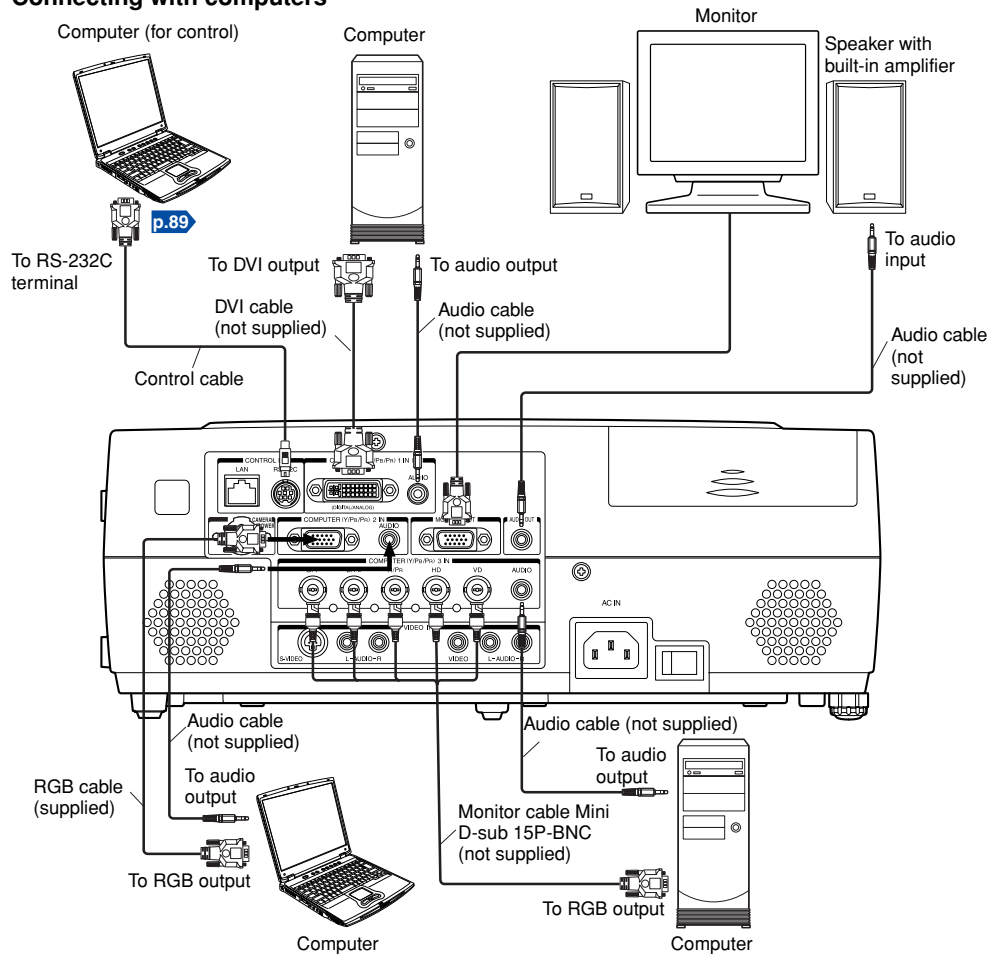

Notes

- Signals are output from MONITOR OUT terminal even in standby mode.
From AUDIO OUT terminal, no audio signal is output.
- Moving pictures played back on computers using DVD software may appear unnatural if it is projected with this projector, but it is not a malfunction.

- The MONITOR OUT terminal outputs analog RGB signals or component video signals (Y/PB/PR) from the COMPUTER 1 IN, COMPUTER 2 IN, or from the COMPUTER 3 IN terminal as selected with the **INPUT** button. If no input is selected, the MONITOR OUT terminal outputs the input signals last selected among the COMPUTER 1 IN, COMPUTER 2 IN, and the COMPUTER 3 IN terminals. (Digital RGB signals are not output.)
- A computer monitor usually cannot accept Y/PB/PR signals correctly.

Connecting with AV equipment

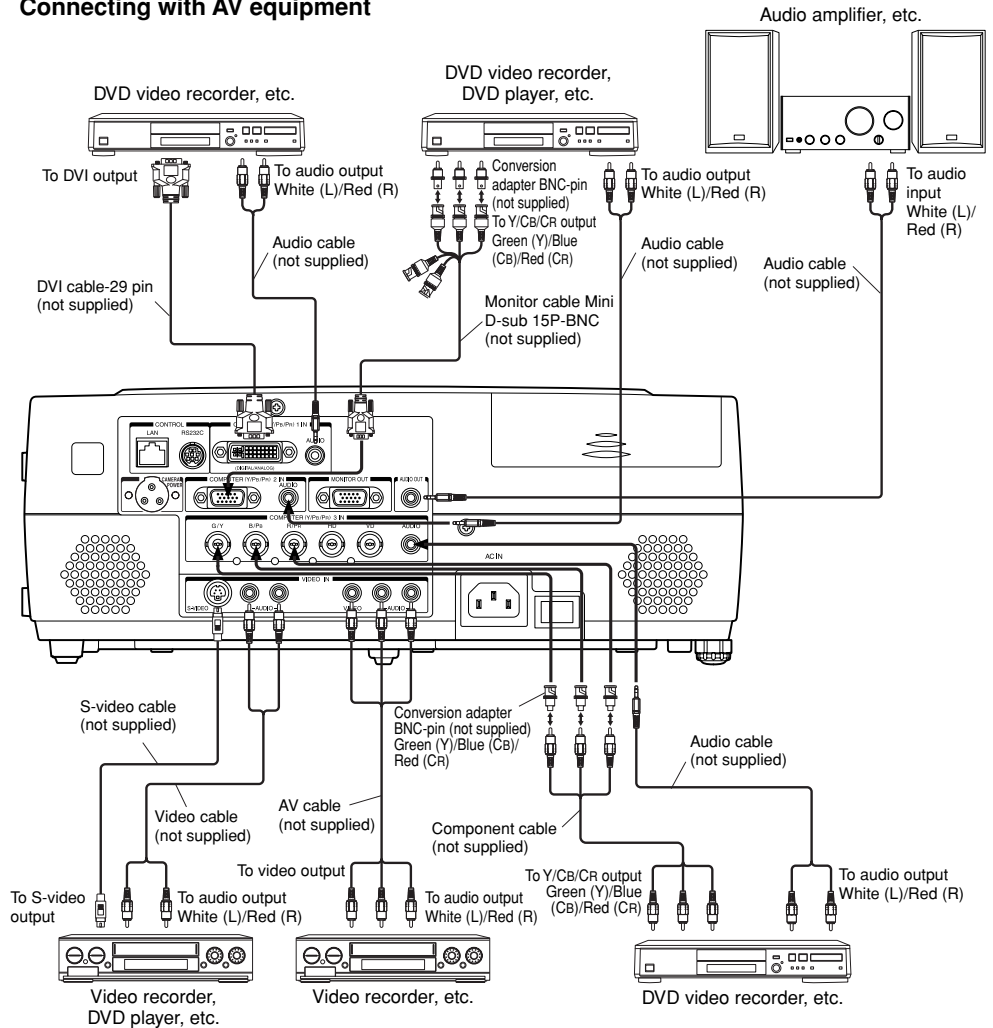

Notes

- When an AUDIO OUT terminal is connected, sound is not output from the projector speaker.
- Output volume of AUDIO OUT terminal can be adjusted by the **VOL** button.

Turning the power on and off

■ Connecting the power cord

- 1 Insert the power cord connector into the AC IN socket of the projector.
- 2 Insert the power cord plug into a wall or other power outlet.

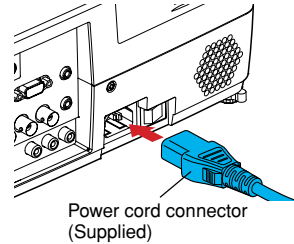

■ Removing the lens cover

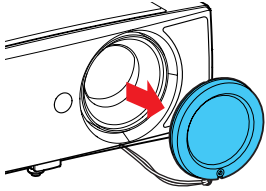

Be sure to remove the lens cover when the power is turned on. If it is left on, it could become deformed due to heat.

■ Turning the power on

- 1 Turn on the main power switch.

The ON/STANDBY indicator will change to orange, indicating standby mode.

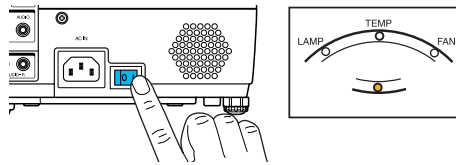

- 2 Press the ON/STANDBY button.

The power turns on with a beep sound (if the beep sound is set to [On]), and the following 3 green indicators light: ON/STANDBY, LAMP, and FAN. After a moment, the start-up screen appears.

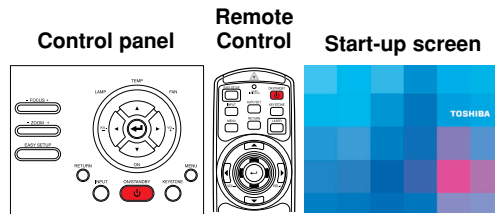

⚠ CAUTION

- Do not look into the lens while the lamp is on. The strong light from the lamp may cause damage to your eyes or sight.
- Do not block the air intake or exhaust. Doing so could cause a fire due to internal overheating.
- Do not place your hands, face, or other objects near the air exhaust. Doing so could cause burns, deform/break the object.

■ Notes

- The start-up screen will disappear after a moment. You can dismiss the start-up screen before this by performing any operation. You can also configure the start-up screen not to appear via the **Display setting** menu [p.41](#).

- The first time you use the projector after purchase, after the start-up screen disappears, the start menu is displayed [p.28](#).
- You can disable the beep sound in the **Display setting** menu [p.41](#).
- When **[Key lock]** is [On], the operation buttons of the projector do not work [p.44](#).
- When **[Password]** is [On], the start-up screen is displayed after the Password entry screen disappears [p.44](#).

■ Turning the power off

- 1 Press the ON/STANDBY button.

A message appears on the screen, confirming that you wish to shut off the power. This message will disappear after a moment. (This operation is no longer valid after the message disappears.)

- 2 Press the ON/STANDBY button again.

A beep sound is made (if the beep sound is set to [On]) and the screen turns off, but the internal cooling fan continues to operate for a short while. Then, the projector goes into standby mode.

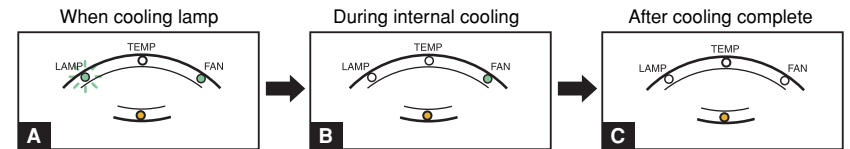

- During cooling, the LAMP indicator flashes. In this state, the power cannot be turned back on. If you are in a hurry, there is no problem with unplugging the power cord or turning off the main power switch in this state.
- After the LAMP indicator goes off, the FAN indicator keeps lighted and the cooling fan continues to operate for a short while, in order to expel excess internal heat.
- In standby mode

■ Note

- The projector consumes about 16W of power in standby. We recommend that you unplug the power cord or turn off the main power switch if you will not be using the projector for an extended period. (When **[Wireless standby]** is [On], it consumes about 23W during standby.)

■ Precautions

- If the power cord is unplugged before cooling is complete, give the lamp time (about 5 minutes) to cool before plugging it back in. If the lamp overheats, it may fail to light, and its lifetime will be shortened.
- After setting the Setting display (2) or changing the settings, be sure to turn off the power using the ON/STANDBY button.

Basic operations

1 Turn on the power.

Turn on the power by following the instructions in **“Turning the power on”** p.26 .
The Easy setup function works to automatically adjust the screen focus and correct the keystone distortion. If RGB signals are input, auto-setting is also made. This operation does not take place when [Easy setup] in the **Default setting** menu is [Off] p.26 .

2 Select the language and the lamp power (When using the first time).

When the projector is used for the first time after purchase, the start menu for language (to display the menus and messages on the screen) and lamp power selection and configuration is displayed in English. (If the screen is out of focus, adjust it according to the step 6.)

1 Use the ▲ or ▼ button to select the desired language and press the ➡ button.

Message for setup confirmation is displayed in a selected language.
Then, the menu for lamp power selection and configuration is displayed. It is automatically set as Standard. To change the setting, follow the step 2.

2 Use the ▲ or ▼ button to select the lamp power and press the ➡ button.

The lamp power, if selected, will be toggled without pressing the ➡ button. The display automatically disappears in a few seconds.

English	English
Français	French
Deutsch	German
Italiano	Italian
Español	Spanish
Português	Portuguese
Русский	Russian
Svenska	Swedish
Türkçe	Turkish
Polски	Polish
日本語	Japanese
中文(简体字)	Chinese (simplified)
中文(繁體字)	Chinese (traditional)
한국어	Korean

Notes

- When the projector is turned on the next time, the start menu does not appear upon startup. However, if [Reset all] is executed from the **Default setting** menu p.44 , the start menu will be displayed the next time when the power is turned on.
- The language can also be set via the **Display setting** menu p.41 and Lamp power via the **Default setting** menu p.44 .
- This owner's manual assumes that English has been selected.

3 Activate the connected device.

Turn on and start the connected device such as a computer.

4 Press the INPUT button.

An image of the connected equipment is projected.
Each time you press the **INPUT** button, it switches to the input of the connected equipment that is outputting video signals.

Notes

- When [Auto input search] is set to [On] in the **Default setting** menu p.44 (factory setting is [On]), the input is switched to the connected equipment that is outputting video signals each time you press the **INPUT** button p.45 .
- If no signal is being output from the connected equipment, pressing the **INPUT** button does not change the input and “There is no other input signal.” will appear.

5 Projector placement angle adjustments

The placement angle and the height of the projected image can be adjusted by the foot adjuster.

1 Lift up the front of the projector to the desired angle, then press the foot adjuster release button.

The foot adjuster extends. Release the button to lock the position.

2 To fine adjust the angle, twist the foot adjuster.

3 To adjust the horizontal angle, use the tilt adjuster.

To stow the foot adjuster, hold up the projector while pressing the foot adjuster release button, then slowly lower the projector.

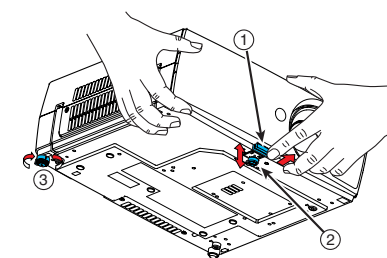

6 Adjusting the screen size and focus

1 Use the ZOOM button to adjust the screen size.

2 Use the FOCUS button to adjust the screen focus.

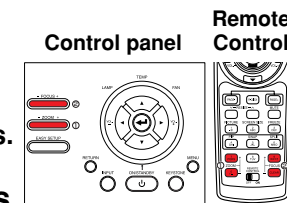

7 Adjusting the volume with the ◀ ▶ buttons

The speaker volume can be adjusted when an audio signal is being input.

Notes

- While a text entry screen (e.g., the Password entry screen) is displayed, the remote control's **FOCUS** and **ZOOM** buttons function as numeric keys, and therefore cannot be used to adjust the screen size or focus. In such a case, use the **FOCUS** and **ZOOM** buttons on the projector to make adjustment or retry after quitting the text entry screen.
- Note that a lamp characteristics may rarely cause the brightness to fluctuate slightly.
- A lamp is consumable item. If used for extended periods, images will appear dark, and the lamp could burn out. This is characteristic of a lamp, and is not malfunction. (The lifetime of the lamp depends on conditions of use.)
- The DMD™ is made using extremely advanced technology, but there may be black spots (pixels that do not light) or bright spots (pixels that are constantly lit) on the panel. Please note that these are not malfunctions.
- Although this projector supports a wide range of RGB signals p.86 , any resolutions not supported by this projector (XGA) will be expanded or shrunk, which will affect image quality slightly. To view high-quality images, it is recommended that the computer's external output should be set to XGA resolution.
- With some models of computer having LCD displays or the like, displaying images simultaneously on the projector and the monitor's display may prevent the images from displaying properly. If this happens, turn off the computer's LCD display. For information on how to turn off the LCD display, see the owner's manual of your computer.
- If no signal is being input from the connected equipment or signal input is stopped while projecting, the “No signal” will appear.
- If a signal not supported by the projector is input, the “Unsupport signal” will appear.
- If an unavailable operation button is pressed, the ✕ icon will appear.

Using handy features

Easy setup

This function automatically adjusts the screen focus and corrects the keystone distortion (Auto focus and Auto keystone functions).

Press the EASY SETUP button on the projector or on the remote control.

The icon  will appear during processing.

- Before pressing the **EASY SETUP** button, be sure to set Auto focus and select the items to be adjusted by Auto adjustment [p.42](#).
- With **[Easy setup]** in the **Default setting** menu set to **[On]**, the screen focus is automatically adjusted and the keystone distortion (vertical and horizontal) is corrected when the power is turned on. (Automatic keystone distortion correction and auto-setting are selected by factory setting.)

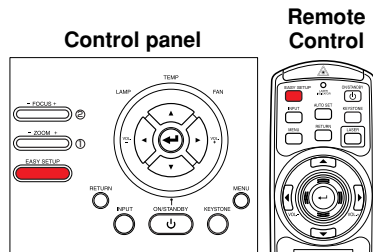

Note

- A message appears on the screen if the auto-adjustment fails.

Precautions

- Auto focus and Auto keystone functions are effective for projecting size from 40" to 100" diagonal (projection distance: 1.17 m to 3 m) at maximum zoom and 40" to 66" diagonal (projection distance: 1.79 m to 3 m) at minimum zoom.
- Depending on the room temperature and brightness as well as the projecting surface condition and material, the adjustment may not be properly made. When such a case arises, adjust the screen focus manually.
- Improper adjustment or correction may also occur if the AF sensor is obstructed or the window gets dirty. Remove the obstruction and clean the AF sensor window in such a case.

Using auto setting (Only for analog input from computer)

This function sets up the projector to the optimum state such as sampling phase, frequency, screen position, and clamp for each type of the input signal by using simple operations.

Press the remote control's AUTO SET button.

For computer input, the  icon will appear during processing. You can set as well by selecting **[Auto setting]** in the **Image adjustment** menu [p.39](#).



Notes

- The image may not be projected or auto adjustment/setting may not be performed correctly for input signals other than those supported by the projector [p.86](#), [p.87](#).
- If auto setting fails adjustment, adjust manually with the **Image adjustment** menu [p.39](#).





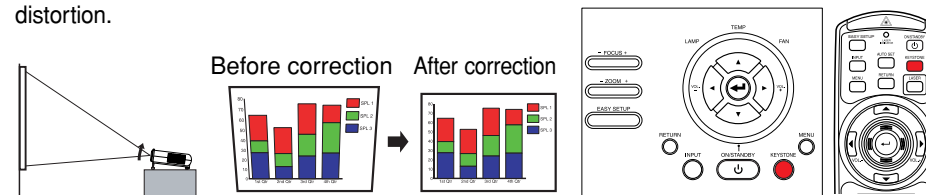



Correcting the keystone distortion

When the projector placement angle against the screen is changed while projecting the image, the picture will undergo keystone (trapezoidal) distortion. This projector is capable of correcting this keystone distortion.







1 Press the KEystone button.

The **Keystone** menu appears. By default, **[Auto keystone]** is selected.

Item	Description
 Auto keystone	Automatically corrects vertical and horizontal keystone distortion. Press  .
 V-keystone	Screen shrinking at bottom   Screen shrinking at top
 H-keystone	Screen shrinking on the left   Screen shrinking on the right

Adjusting vertical distortion [Auto]

2 Press the button.

The vertical and horizontal keystone distortion is automatically corrected. During processing, the icon  will appear. When the processing is finished, the **Keystone** menu appears again. If you wish to make fine adjustment, use the  button to select **[V-keystone]**, and adjust with the   buttons.

Adjusting vertical distortion [Manual]

1 Press the KEystone button.

2 Select **[V-keystone]** by the button.

3 Use the buttons for keystone adjustment.

Adjusting horizontal distortion [Manual]

1 Press the KEystone button.

2 Select **[H-keystone]** by the button.

3 Use the buttons for keystone adjustment.

When the adjustment is finished, the menu automatically disappears. The menu also disappears when the **KEystone** or **RETURN** button is pressed.

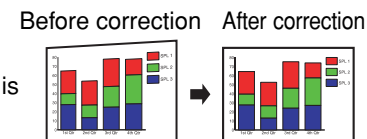

Using handy features (Continued)

Notes

- A message appears on the screen if the automatic keystone distortion correction fails.
- Depending on the amount of keystone adjustment and the content of images, some information may be lost, or the picture quality may suffer.
- To manually adjust both vertical and horizontal keystones, adjust the vertical keystone first then the horizontal.

Precaution

- Depending on the room temperature and brightness, the placement as well as the projecting surface condition and material, the correction may not be properly made. When such a case arises, make correction manually.

Resizing image

The projected image can be resized (zoomed in/out).

1 Press the remote control's RESIZE button.

Each time you press the RESIZE  button, zoom ratio is up. You can keep pressing.

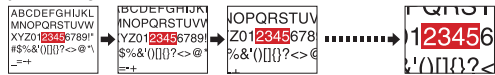

2 To zoom out, press the remote control's RESIZE button.

Each time you press the RESIZE  button, zoom ratio is down. You can keep pressing. (However, the image cannot be smaller than the original size.)



3 To move the area to zoom in, use the buttons.

You can keep pressing.



4 To reset the zoom, press the RETURN button.

The image is reset to the original size.

Notes

- The  icon appears while resizing.
- Operating a function other than Mute will release resizing.
- As zooming is processed digitally, the image quality is degraded in larger zoom ratio.
- During resizing or moving the zooming area, the image may be distorted.

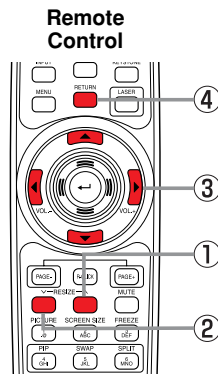

Cutting off the picture and sound temporarily (Mute)

When you want to project the images of another projector, overhead projector, etc. temporarily, this projector's images and sound can be turned off.

Press the remote control's MUTE button.

The picture and sound are cut off. (The Mute function is released when pressing the MUTE button again.)

Notes

- The  icon will appear while mute is in effect.
- Operating any other functions will also cancel the muting.

Changing picture mode

The projected image mode can be selected.

Press the remote control's PICTURE button.

Pressing the button switches Bright/Standard/True color in turn.

Note

- [Picture mode] of the Image adjustment menu has the same function [p.39](#).

Changing screen size

The screen size for the projected image can be changed.

Press the remote control's SCREEN SIZE button.

Pressing the button switches Full/Thru/Wide in turn.

Notes

- Thru display is available for computer-input images.
- [Screen size] of the Display setting menu has the same function [p.41](#).
- If you use this function on commercial video software, broadcast or cable-broadcasting except for the purpose of your private viewing and listening, it may infringe the copyright protected by the copyright laws.

Freezing the image (Freeze)

The image being projected can be frozen. This function is to be used to pause a video during a presentation, etc.

Press the remote control's FREEZE button.

The picture pauses. (The Freeze function is released when pressing the FREEZE button again.)

Notes

- The  icon will appear while freeze is in effect.
- Other operation will also release the freeze.
- Even if an image is frozen on the projector, the pictures are running on the video or other equipment.
- If you use this function on commercial video software, broadcast or cable-broadcasting except for the purpose of your private viewing and listening, it may infringe the copyright protected by the copyright laws.

Remote Control



Remote Control



Remote Control



Remote Control



Using handy features (Continued)

■ Display a sub screen (PIP function)

Another image can be added in smaller size (referred as sub screen in this manual) to the projected image (referred as main screen).

● Press the remote control's PIP button.

A sub screen is displayed in the currently projected image (main screen).

To swap the main and sub screens, press the remote control's **SWAP** button.

To hide the sub screen, press the **PIP** button again.

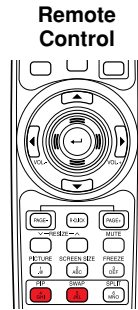
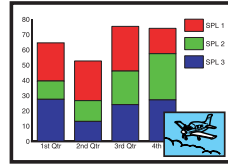

■ Notes

- Sound of the main screen is output.
- Input select, display position and size of the sub screen can be changed in the **PIP** menu.
- Operating a function other than Mute, Freeze and volume control will release PIP mode.
- If you use this function on commercial video software, broadcast or cable-broadcasting except for the purpose of your private viewing and listening, it may infringe the copyright protected by the copyright laws.

■ Sub screen setting

Pressing the **MENU** button while the sub screen is displayed displays the **PIP** menu. This menu sets up the sub screen.

To hide the menu, press the **RETURN** button.

Item ▲ ▼	Description
PIP size	Sets the sub screen size. Large ◀ ▶ Medium ◀ ▶ Small
PIP position	Sets display position of the sub screen. ◻ ◀ ▶ ◻ ◀ ▶ ◻ ◀ ▶ ◻
PIP input	Selects the input source for the sub screen. When the main screen is input from computer or Y/Pb/Pr: Press ◀ or ▶, toggle the input with ▲ ▼ and fix selection with ◀. Video/S-video When the main screen is input from video or S-video: Press ◀ or ▶, toggle the input with ▲ ▼ and fix selection with ◀. Computer 1 (Digital) / Y/Pb/Pr 1 (Digital) / Computer 1 (Analog) / Y/Pb/Pr 1 (Analog) / Computer 2 / Y/Pb/Pr 2 / Computer 3 / Y/Pb/Pr 3 / Wireless/Card / USB memory

■ Displaying two screens (SPLIT function)

This function displays two screens at a time.

● Press the remote control's SPLIT button.

The projected image moves to the left (main screen), and a new image is displayed to the right (sub screen). To switch the sub and main screens, press the remote control's **SWAP** button.

To hide the sub screen, press the **SPLIT** button again.

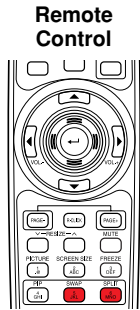
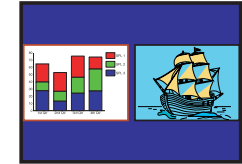

■ Notes

- Sound of the main screen is output.
- Size of the screens and input source of the sub screen can be changed in the **SPLIT** menu.
- Compared with the main screen, the sub screen may suffer some slight image degradation.
- Operating a function other than Mute, Freeze and volume control will release the SPLIT mode.
- If you use this function on commercial video software, broadcast or cable-broadcasting except for the purpose of your private viewing and listening, it may infringe the copyright protected by the copyright laws.

■ SPLIT function setting

Pressing the **MENU** button while two screens are displayed displays the **SPLIT** menu. This menu sets up both screens.

To hide the menu, press the **RETURN** button.

Item ▲ ▼	Description
Size	Sets size of both screens. ◻ ◀ ▶ ◻
Sub input	Selects the input source for the sub screen. When the main screen is input from computer or Y/Pb/Pr: Press ◀ or ▶, toggle the input with ▲ ▼ and fix selection with ◀. Video/S-video When the main screen is input from video or S-video: Press ◀ or ▶, toggle the input with ▲ ▼ and fix selection with ◀. Computer 1 (Digital) / Y/Pb/Pr 1 (Digital) / Computer 1 (Analog) / Y/Pb/Pr 1 (Analog) / Computer 2 / Y/Pb/Pr 2 / Computer 3 / Y/Pb/Pr 3 / Wireless/Card / USB memory

■ Note

- To enlarge the screen fully, select **[Full]** for **[Size]**.

Using handy features (Continued)

■ Screen combination of PIP and SPLIT functions

Group	Input signal
A	Computer 1 (Digital) / Y/PB/PR 1 (Digital)
	Computer 1 (Analog) / Y/PB/PR 1 (Analog)
	Computer 2 / Y/PB/PR 2
	Computer 3 / Y/PB/PR 3
	Wireless/Card
	USB memory
B	Video
	S-video

● For PIP function

A: Main screen, B: Sub screen

A: Sub screen, B: Main screen

You cannot display two screens of the same group in the **PIP** mode.

● For SPLIT function

A, B or B, A is available.

You cannot display two screens of the same group in the **SPLIT** mode.

■ Password function

When the password function is added and [Password] is set to [On], image projection requires an entry of the preset password at power-on.

To add the password function, perform the following procedure:



(The password function, once added, cannot be deleted. Set [Password] to [Off] if you do not want to use it after addition.)

① Set the projector to the operating status or the standby mode.

② Keep pressing the  button for about 10 seconds until a beep sounds.

The password function is added when the steps up to here have been completed. It is also added to the Default setting menu.

● How to set password (from [Off] to [On])

① Select [Password] in the Default setting menu and press the  or  button.

The password setting confirmation screen is displayed. ([OK] or [Cancel])

② Select [OK] and press the  button.

The password entry screen is displayed.

③ Enter a four-digit number for the password using numeric keys of the remote control.

The input number appears as [****].

④ Re-enter the same password for confirmation.

When the password is confirmed, the setting is complete and the password becomes [On].

If the password is wrong, repeat the procedure from step ②.

● How to operate when password is [On]



① Turn on the power.

② The lamp lights and the password entry screen appears.

③ Enter the password using numeric keys of the remote control.

If the entered password is correct, the start-up screen appears and the projector goes into normal operation. If the password is wrong, a message appears to prompt you to re-enter the password. If you enter a wrong password for more than 5 times, the projector will automatically power off and enter standby mode.

● How to cancel password (from [On] to [Off])

① Select [Password] in the Default setting menu and press the  or  button.

The password entry screen is displayed.

② Enter the password using numeric keys of the remote control.

③ The password cancel confirmation screen is displayed. ([OK] or [Cancel])

④ Select [OK] and press the  button.

The [Password] is canceled and becomes [Off].

■ Note

- The password entry screen appears when the power is turned back on only after the main power switch is turned off or the power cord is unplugged.

If you forgot the password, please inquire your dealer.

Using the menus

You can call up on-screen menus, and conduct a number of adjustments and settings using the operation buttons [p.16](#) on the control panel (main unit side) and remote control.

How to use the menus

The menu shown below is for operation instructions purposes and might differ from the actual display.

1. Press the MENU button Display the **Setting display** menu.

2. Select a Category

Select a category by using . There are following five categories:

- Image adjustment menu** [p.39](#)
- Display setting menu** [p.41](#)
- Default setting menu** [p.44](#)
- Control setting menu** [p.46](#)
- Status display menu** [p.48](#)

Displays the current adjustments and settings of selected category. Item shown with gray cannot be adjusted with the current input source.

3. Adjustments & Settings Press or to open the menu.

These marks signify that there are setting screens. Press or to display a list of setting screens.

These marks signify that there are options. Press or to display a list of options.

These marks signify that the items can be adjusted/set by using .

These marks signify that the items can be selected from the list by using . After an item is selected, apply it by pressing .

Toggle items with . Select items with and press . Fix selection with .

* When no item is changed, press .

The figure shows displays given for operation instructions purposes. As the display may differ depending on the item, use the following pages as a reference.

4. Back RETURN button

5. Press the MENU button. The Setting display (2) menu is displayed. [p.51](#)

6. End Press the MENU button or RETURN button.
(The menu disappears 30 seconds after the last operation.)

The image adjustment menu

Use this menu to set or adjust image-related items. Items that can be set or adjusted are marked with “Yes”, and those that cannot are marked with “No”. (When an item is masked, it indicates that you cannot select for the current input.)

Item	Description	Digital (DVI)		Analog (D-SUB)(BNC)		Video	S-video	PC card	USB
		RGB	Y/Pb/Pr	RGB	Y/Pb/Pr				
Contrast	Adjust the image contrast. Lower Higher	Yes	Yes	Yes	Yes	Yes	Yes	Yes	Yes
Brightness	Adjust the brightness of the image. Darker Brighter	Yes	Yes	Yes	Yes	Yes	Yes	Yes	Yes
Color	Adjust the color of the image. Lighter Deeper	No	Yes	No	Yes	Yes	Yes	No	No
Tint ¹	Adjust the tint of the image color. Reddish Greenish	No	No	No	No	Yes	Yes	No	No
Sharpness	Adjust the sharpness of the image. Softer Sharper	No	Yes	No	Yes	Yes	Yes	No	No
Noise reduction ²	Set the function to reduce screen noise. On (Enable) Off (Disable)	No	Yes	No	Yes	Yes	Yes	No	No
Picture mode	Press . Toggle the picture mode with . Bright/Standard/True color	Yes	Yes	Yes	Yes	Yes	Yes	Yes	Yes
R-level	Adjust red of the image color. Less red More red	Yes	Yes	Yes	Yes	Yes	Yes	Yes	Yes
G-level	Adjust green of the image color. Less green More green	Yes	Yes	Yes	Yes	Yes	Yes	Yes	Yes
B-level	Adjust blue of the image color. Less blue More blue	Yes	Yes	Yes	Yes	Yes	Yes	Yes	Yes
NTSC mode ³	Set the black level with . US : NTSC (US) mode JAPAN : NTSC (JAPAN) mode	No	No	No	No	Yes	Yes	No	No
Auto setting	Automatically adjusts items such as the sampling phase depending on the type of input signal.	No	No	Yes	No	No	No	No	No
Phase	Adjust with to eliminate flicker.	No	No	Yes	No	No	No	No	No
Frequency	Adjust with to eliminate periodic patterns and flickering when many vertical lines appear on the screen.	No	No	Yes	No	No	No	No	No
H-position	Adjust the horizontal position of the image. Move left Move right	No	No	Yes	No	No	No	No	No
V-position	Adjust the vertical position of the image. Move down Move up	No	No	Yes	No	No	No	No	No

Using the menus (Continued)

Item ▲ ▼	Description	Digital (DVI)		Analog (D-SUB)(BNC)		Video	S-video	PC card	USB
		RGB	Y/Pb/Pr	RGB	Y/Pb/Pr				
Clamp 1	Adjusts the clamp pulse position. Lower ◀ ▶ Higher	No	No	Yes	No	No	No	No	No
Clamp 2	Adjusts the clamp pulse width. Narrower ◀ ▶ Wider	No	No	Yes	No	No	No	No	No
Equalizer	Reduce noise on the screen. Adjust with ◀ ▶.	Yes	Yes	No	No	No	No	No	No

*1: **[Tint]** and **[NTSC mode]** can be displayed and adjusted only when the video signal is set to **[NTSC]** and **[NTSC4.43]**.

*2: **[Noise reduction]** may not work depending on signal type.

*3: **[NTSC mode]** is set to JAPAN when the language is set to Japanese. It is set to US for other languages.

■ The display setting menu

Use this menu to set screen display-related items.

(The items in gray color cannot be set with the current input selection.)

Item ▲ ▼	Description
Screen size	 (Full): Display with 1024 × 768 dot resolution (Thru): Display with sampling resolution (for computer input only) (Wide): Wide-screen display
Language	Select one of the languages below to use for displaying the menu and messages [◀ or ▶]: Enter setting mode → [▲▼]: Selection → [Apply: ↵] English/Français/Deutsch/Italiano/Español/Português/Русский/Svenska/Türkçe/Polksi/日本語/中文(簡体字)/中文(繁体字)/한국어
Background	Screen to display when there is no input signal [◀ or ▶]: Enter setting mode → [▲▼]: Selection → [Apply: ↵] Logo/Blue/None
Icon	Display icons as function guides On ◀ ▶ Off
Beep	Sound a beep when operation is done. On ◀ ▶ Off
Start-up screen	Display start-up screen when power is turned on On ◀ ▶ Off
User logo	Display a logo customized by the user for the start-up screen or when there is no input signal. [◀ or ▶]: Enter setting mode → [▲▼]: Selection
	Logo registration Press ◀ to display the registration menu.
	Display style
	Background Black ◀ ▶ Blue ◀ ▶ White
	Logo confirmation Press ◀.
	Reset logo Yes ◀ ▶ No

● Detailed description

[Screen size]

- If “Thru” is selected for **[Screen size]**, portions exceeding the native resolution (1024 × 768 pixels) will not appear on the screen. Note that for RGB signals with clock frequency 140MHz or lower, all input pixel signals are sampled. However, if the clock speed is higher than this, the RGB pixel signal is thinned before sampling.
- If you use the screen size setting function on commercial video software, broadcast or cable-broadcasting programs to display images with the varying aspect ratio except for the purpose of your private viewing and listening, it may infringe the copyright protected by the copyright laws.

Using the menus (Continued)

[Background]

- TOSHIBA is set for [Logo] by factory setting.
- If user's logo has been registered, it is displayed when [Logo] is set for background.

[Start-up screen]





If user's logo has been registered and this setting is [On], the logo is displayed at start-up.

[User logo]

Registers a part of the image that is input from computer and displays it as a logo at start-up and when no signal is input.

<Logo registration>

● How to register user logo



- 1 Select [User logo] in the Display setting menu, and press the  or  button.
- 2 Select <Logo registration> from the displayed menu list and press the  button.
- 3 The registration area is displayed for confirmation. Select [OK] or [Cancel] and press the  button.
 - If the picture does not fall within the area, operate the computer to scroll the screen.
- 4 Press the  button to register.
- 5 Registration starts.
 - A message is displayed while registration is in process.

■ Notes

- You can register a logo from computer input only.
- The area that can be registered is 512 × 384 dots at the center of the screen. To register a company logo, prepare the image within the limit.
- Only one logo can be registered. When a new image is registered, the old one is erased.
- The time needed to register or display the image varies depending on the data size.
- If you use this function on commercial video software, broadcast or cable-broadcasting except for the purpose of your private viewing and listening, it may infringe the copyright protected by the copyright laws.

<Display style>

Select the size of the registered logo (except during the PIP and SPLIT modes).

- : Displays the registered image in original size at center of the screen.
- : Displays the registered image by enlarging fully in the screen.
(As processed digitally, the image quality is degraded.)

<Background>

Sets background color when [Center] is selected for the logo display mode.

<Logo confirmation>

You can preview the registered logo.









































































<Reset logo>

You can reset the registered logo, display style and background to the factory setting. (The logo set for the start-up screen and background is reset.)

Using the menu (Continued)

■ The default setting menu

This menu shows placement status and other settings.

Item  	Description
 Projection mode	Sets projection mode in accordance with Placement Style. p.22  (Standard)  (Rear)  (Ceiling)  (Rear ceiling)
 Blackboard mode	When projecting on a non-screen surface, select a color in accordance with the projecting surface. Press  and switch with  and  . Off/Green/Black/Brown/Blue/Beige
 No signal power off	Set the time to wait for the power to be turned off after the last operation is made with no input signal. Press  and switch with  and  . Off (not turned off)/1 min./5 min./10 min./30 min./60 min.
 Auto input search	Set whether the input with signals is only selected or not. On   Off
 Power on	Sets whether to turn on the power when the ON/STANDBY button is pressed (Manual), or when the power cord is plugged in (Auto). Manual   Auto
 Easy setup	Set the items of Easy setup and power ON/OFF. [ or  : Enter setting mode] → [  : Select item] → [On   Off]
	 Auto focus On
	 Auto keystone On   Off
	 Auto-setting On   Off
	 Power on Easy setup On   Off
 Lamp power	Sets the lamp power. Low   Standard
 Fan mode	Sets the cooling fan speed. Standard   High
Wireless standby	Switch on/off the wireless LAN while the projector is in standby. On   Off
 Remote control	When two or more projectors are used and controlled by the remote control respectively, this menu sets the code for the projector and the remote control. [ or  : Enter setting mode] → [  : Select item] → [  : Select from 1, 2, 3, 4] → [ : Confirm] → [  : Select OK to end] Press [Cancel] to return.
 Key lock	Lock the control panel buttons. [ or  : Enter setting mode] → [  : Select item] → [  : Select On/Off] → [ : Confirm] → [  : Select OK to end] Press [Cancel] to return.
 Reset all	Press  . (The password and user logo are not reset.) Resets all adjustments and settings to their factory settings. Yes   No
 Password	Password function p.36 Off   On When [Password] is [On], the Password Setting screen is displayed.

● Detailed description

[Blackboard mode]

Projects the image in colors more like projecting on a screen.



■ Precaution

- The projected image may differ depending on the type, color, and material of the blackboard and wall even if the selected color is the same as the projected screen.

[Auto input search]

[On]: Automatically searches the signals that can be projected, and switches input from the connected device that outputs the signals each time the **INPUT** button is pressed. The input from the connected device that outputs no signals is skipped.

[Off]: Displays the **Input select** menu.

Toggle with   buttons and press  button. (The input without signals can be selected.)

[Power on]

Note that if [**Power on**] is set to [**Auto**], then if the **main power switch** is ON when power is restored after a power outage, the projector will come on.

[Easy setup]

<Auto keystone>: Switches on/off the automatic keystone distortion correction when the **EASY SETUP** button is pressed or when **Power on Easy setup** is set to **ON**.

<Auto-setting>: Switches on/off the auto-setting function when the **EASY SETUP** button is pressed or when **Power on Easy setup** is set to **ON**.

<Power on Easy setup>: Switches **on/off** the Easy setup operation when the power is turned on.

■ Note

- The Easy setup automatically switches off when [Ceiling] or [Rear ceiling] is selected for projection mode.

[Lamp power]

When [**Lamp power**] is set to [**Low**], the screen becomes a little darker, but the cooling fan noise gets quieter.

[Fan mode]

Setting [**Fan mode**] to [**High**] increases the cooling fan speed. Set this option to use the projector, for example, at high altitude (over 1,500 meters above sea level).

[Wireless standby]

When [**Wireless standby**] is set to [**On**], the wireless LAN is switched to the standby state as the projector enters standby. While the wireless LAN is in standby, the projector can be powered on using the remote control function of the Wireless Utility.

When [**Wireless standby**] is set to [**Off**], the projector cannot be powered on with the remote control function of the Wireless Utility.

[Remote control]

Sets a remote control code from 4 types. You can set each code respectively for up to 4 projectors. The factory setting is [1].

To switch codes, set the same code for the projector and the remote control.

A remote control code is applied after the setting is done.

- You cannot operate the remote control if the codes of the projector and the remote control do not match.

● Remote control code setting for remote control

Remove the battery cover and set the same **remote control code switch** as the projector. [p.16](#) (Use a screwdriver with thin tip to set.)

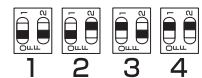

[Key lock]

Protect from operating errors by locking on the control panel buttons of the projector. (The remote control operations are available.)

Control panel operations are locked after the setting is done.

- To release the key lock, press the control panel's **RETURN** button for 10 seconds. The key lock is released with a beep sound.

Input select menu

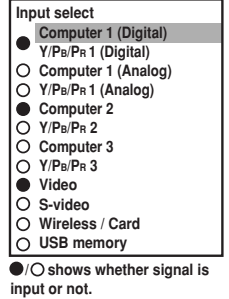









































Using the menus (Continued)

■ The control setting menu

This menu sets items regarding wired LAN.

By this setting, you can transmit operation status messages from the projector to the specified E-mail address.

Item  	Description
 Wired LAN	[ : Wired LAN setting] → [  : Select item]
	Projector name: Enter a character string (0 to 64 characters) using numeric keys of the remote control.
	DHCP: Use   Not use
	IP address: Enter a character string using numeric keys of the remote control.
	Subnet mask: Enter a character string using numeric keys of the remote control.
	Gateway: Enter a character string using numeric keys of the remote control.
	Confirm: [OK   Cancel] → 
 Email	[ : E-mail setting] → [  : Select item]
	Status notification: On   Off
	SMTP server: Enter a character string using numeric keys of the remote control.
	Port number: Enter a character string using numeric keys of the remote control.
	Destination address: Enter a character string using numeric keys of the remote control.
	Confirm: [OK   Cancel] → 
 PJLink	[ : PJLink setting] → [  : Select item]
	PJLink authentication: On   Off
	Password: Enter a character string (1 to 32 characters) using numeric keys of the remote control.
	Confirm: [OK   Cancel] → 

● Detailed description

[Wired LAN]

<**Projector name**>: Setting a projector name helps you identify each of the projectors that are connected to the network.

- You cannot set a projector name starting with ERR.

<**DHCP**>: When <**DHCP**> is set to [Use], an IP address is automatically assigned to the projector by a DHCP server. In case of a network that an IP address cannot be assigned automatically, set <**DHCP**> to [Not use].

When <**DHCP**> is set to [Not use], ask your network administrator for **IP address**, **subnet mask**, and **gateway**, then set the following items manually:

<**IP address**>: This is a unique number assigned for a terminal to connect to a network. The format is a quartet of 3-digit decimal number. (Example:

111.112.xxx.xxx)

<**Subnet mask**>: For dividing the network, the subnet mask determines the range of an IP address assigned to a terminal. (Example: 255.255.xxx.xxx)

<**Gateway**>: Gateway specifies a network device like a router when accessing a server outside the network. It is identified by an IP address. (Example: 111.112.xxx.xxx)

[Email]

<**Status notification**>: Sends alarm information to the specified E-mail address when an error such as lamp blowout occurs.

<**SMTP server**>: Set an IP address of the SMTP server.

<**Port number**>: Enter a port number of the SMTP server.

<**Destination address**>: Enter within 60 characters. (Example: xxx@xxx.xxx)

[PJLink]

<**PJLink authentication**>: Set whether or not to authenticate the user by password when the projector is accessed via the **PJLink**-compliant Software Application. (Set [On] or [Off].)

<**Password**>: Enter a password for confirmation when the above <**PJLink authentication**> is set to [On].











■ Precautions

- When purchased, <**PJLink authentication**> is set to [Off] and <**Password**> is not set by factory setting. You are recommended to make authentication setting as soon as possible.
- If you forget a password, set it again.

● Character entry

Enter characters using numeric keys of the remote control.

The character is entered with a beep sound if the beep sound is set to [On].

Remote control button	Character entry mode	
	Items using characters, numbers, and symbols (e.g., projector name and destination address)	Number only
	"1" " " "@" " " _ "	"1"
	"2" "A" "B" "C" "a" "b" "c"	"2"
	"3" "D" "E" "F" "d" "e" "f"	"3"
	"4" "G" "H" "I" "g" "h" "i"	"4"
	"5" "J" "K" "L" "j" "k" "l"	"5"
	"6" "M" "N" "O" "m" "n" "o"	"6"
	"7" "P" "Q" "R" "S" "p" "q" "r" "s"	"7"
	"8" "T" "U" "V" "t" "u" "v"	"8"
	"9" "W" "X" "Y" "Z" "w" "x" "y" "z"	"9"
	"0" "space!"#\$%&'()*+,-./:;<=>?@[\\]^_`{ }~"	"0"
	Deletes one character.	Deletes one character.

Using the menu (Continued)

■ Displaying Information (Status display)

This displays information about the input signal, lamp use time, LAN connection status, etc.

“Yes”: displayed, “No”: not displayed

Item	Description	Computer	Y/P _B /P _R	Video S-video	Wireless/ Card	USB memory
Projector						
Input	Input source name	Yes	Yes	Yes	Yes	Yes
Mode name	RGB input mode ^[Note 1]	Yes	No	No	No	No
Resolution	Resolution (in dots)	Yes	No	No	No	No
Frequency	Sync frequency	Yes	No	No	No	No
Sync	Sync signal polarity ^[Note 2]	Yes	No	No	No	No
Signal format	Y/P _B /P _R signal format	No	Yes	No	No	No
Video mode	Color method of video signal	No	No	Yes	No	No
Lamp time	Time of lamp use ^[Note 3]	Yes	Yes	Yes	Yes	Yes
Lamp reset count	The count for lamp replacement	Yes	Yes	Yes	Yes	Yes
Total time	The total time that this projector is used.	Yes	Yes	Yes	Yes	Yes
Version	Firmware version ^[Note 4]	Yes	Yes	Yes	Yes	Yes
Wired LAN						
Connection status	Displays connection status of LAN.	Yes	Yes	Yes	Yes	Yes
IP address	Displays the IP address.	Yes	Yes	Yes	Yes	Yes
Subnet mask	Displays numeric value of subnet mask.	Yes	Yes	Yes	Yes	Yes
Gateway	Displays numeric value of gateway.	Yes	Yes	Yes	Yes	Yes
MAC address	Displays MAC address of the projector. ^[Note 5]	Yes	Yes	Yes	Yes	Yes
PJLink class	PJLink version	Yes	Yes	Yes	Yes	Yes

Notes

- 1: The mode of supported RGB signals [p.86](#) is shown.
- 2: Sync signal polarity shown as P (positive) or N (negative) for [H/V].
- 3: Displays [Lamp time] as a measure of when the lamp should be replaced. (Cannot be used as a counter of guaranteed lamp time.) When the displayed time approaches 2,000 hours, consult with a store about getting a TLPLW6 replacement lamp (sold separately) prepared.
- 4: [Version] shows the version of the projector's internal control program. This version is referred to for customer service, etc.
- 5: In case that “-----” appears for MAC address, please contact your dealer.

■ Note

- The displayed information will not be refreshed if the status changes. To refresh the information, dismiss the display, then display it again. The information regarding wired LAN is refreshed every time it is displayed.

How to use the PC card slot

The wireless LAN PC card enables you to connect the projector wirelessly with a personal computer that supports IEEE802.11b/g based wireless LAN. [p.50](#) (Please note that communication between all the computers based on IEEE802.11b/g and this projector is not guaranteed.) You can also use a commercially available memory card to project JPEG image files using this projector. [p.58](#) Please follow the steps below when removing or mounting a PC card.

■ Mounting a PC card

① Remove the slot cover.

Press lightly on the circle (“O”) while sliding the cover in the direction of the arrow.

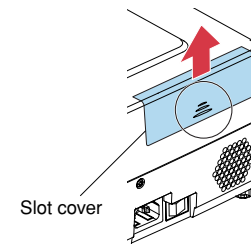

② Insert the PC card.

After making sure of the card orientation, press it in firmly until it stops.

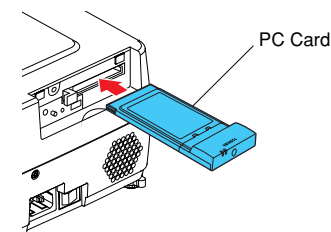

■ Removing a PC card

① Look at CARD indicator.

If it is off, proceed to step ④.

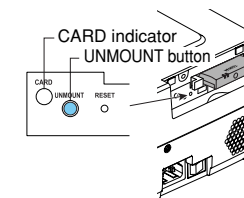

② Press the UNMOUNT button.

Begins processing for PC card removal.

③ Wait until CARD indicator goes out.

Never remove the PC card while lit. Doing so could damage the PC card or corrupt your data.

④ Press the Eject button.

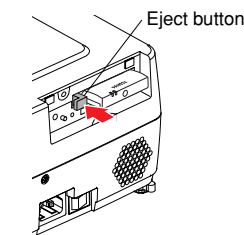

■ If CARD indicator turns red

Press the RESET switch with a thin pin or similar implement (it is at the bottom of a recess).

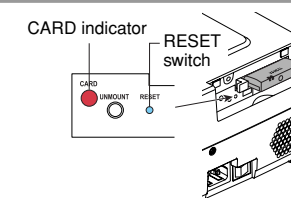

How to use the USB terminal

This projector can connect with a commercial USB memory and a USB memory card reader that are USB2.0 compliant, a digital camera or the like and display the JPEG files saved in those devices. [p.59](#)

(Toshiba does not guarantee the operation of all USB 2.0-compliant devices.)

To connect or disconnect a USB device, use the following procedure:

■ Connecting USB memory

① Remove the slot cover.

Slightly push the circled part and slide toward the arrow.

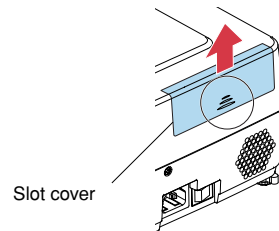

② Plug the USB memory.

Make sure the orientation is correct then plug the USB memory in until it stays securely.

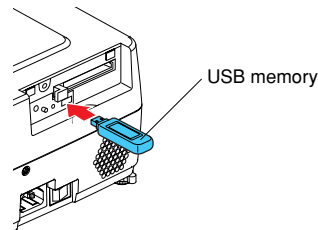

■ Disconnecting USB memory

① Press the MENU button twice to display the Wireless/Card menu then select and run Slideshow settings and Unplug device.

The processing for disconnecting a USB device starts.

② The message "Safe to remove the USB device". appears on the screen.

③ Unplug the USB device.

Be sure to perform the above operations. Disconnecting a USB device during operation may cause a malfunction or data corruption.

■ Precautions

- The USB terminal does not support the supplied mouse remote control receiver or a commercial mouse controller.
- A USB hub is also not supported.
- Turning off the main power or disconnecting the power plug while the USB device is operating may cause a malfunction or data corruption.

Setting up the wireless LAN

■ Functions

The following functions are available via wireless communications, when the wireless LAN PC card and dedicated **Wireless Utility** software [p.66](#) included with this projector are used.

Note: A wireless LAN PC card except the supplied one (or recommended by Toshiba) does not work with this product. Please ask your dealer about the available wireless LAN PC card.

1) Displaying a computer's screen via the projector

The computer's desktop screen can be sent, as well as the screens of a variety of software applications, to the projector for display.

2) Displaying an image saved on a computer via the projector

JPEG files can be sent to the projector for display.

3) Operating the projector by means of a computer

Some of the same functions available from the remote control can be performed.

■ Communication mode

This projector supports both Ad hoc and Infrastructure Communication modes.

◆ Ad hoc communication mode

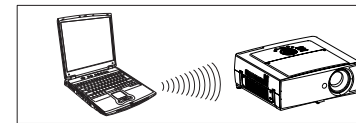

This is transmission mode to communicate between wireless LAN equipment.

Wireless communication can be performed via the simple configurations. This function can only be used if the projector is in range of the computer's wireless signals.

For security reason, confirm the specifications of your computer for the distance that the radio wave can reach. The coverage of this projector may vary, depending on the computer and the surrounding environment. When tested with a PC manufactured by Toshiba with built-in wireless LAN system, the coverage is approximately 60 m with an unobstructed path between the projector and computer placed indoors. This figure is not guaranteed and should be considered as merely a guideline.

◆ Infrastructure communication mode

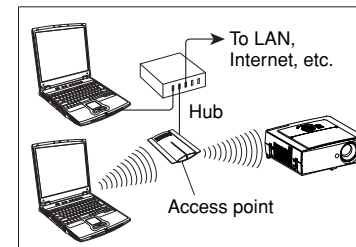

A mixed wireless and wired LAN can be created via access points. Connecting to the rest of the world via a wired LAN or the Internet generally requires a high level of security.

Use the appropriate transmission mode for your network environment.

Setting up the wireless LAN (Continued)

■ Caution when using the wireless LAN functions

The Wireless LAN in this unit uses the 2.4 GHz waveband. If there is a similar wireless LAN in the area, or a wireless device using the 2.4 GHz waveband, or a microwave oven, the communication efficiency of this apparatus will be reduced, and may become unusable, but it is not a fault. If this happens, check an area away from the current location that will not cause radio interference to medical, industrial and public equipment, and change to it, or stop using the unit.

■ Setup using the Setting display (2)

● Projector settings (Be sure to read this subsection.)

The factory settings can be used as-is. However, if you need higher security, the projector settings should be changed.

1. Press the MENU button twice



The Setting display (2) is displayed.
* Appears only when Wireless/Card or USB memory input.

2. Select a Category

Select a category by using



The following three categories are available:

-  **Wireless utility setup** p.54
-  **Slide Show setup** p.59
-  **Status display** p.64





Displays the current settings of selected category. Item shown with gray cannot be set with the currently selected input source.

3. Make settings

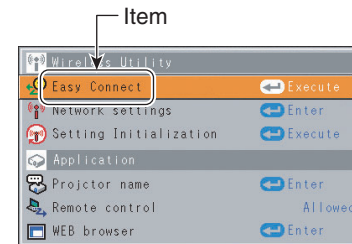
Press  or  to open the menu.



These marks signify the items can be selected from the list by using  . After an item is selected, apply it by pressing .

The figure shows a typical example. As the display may differ depending on the item, use the following pages as a reference.

4. Back RETURN button

5. End Press the MENU button or RETURN button. (The menu disappears 30 seconds after the last operation.)

■ Note

- When the item (2) of the Setting display menu is set or when the setting window disappears after the settings are changed, the message "Saving..." appears on the screen. Be sure not to turn the projector power off or unplug the power cord in such a case.

Setting up the wireless LAN (Continued)

■ Setting Wireless Utility

If you select **Wireless Utility**, the following items can be set.

Item ▲▼	Description
Easy Connect (USB)	[Yes No] → [Apply:]
Network settings	<p> Mode: Ad Hoc Infrastructure </p> <p> Channel: Select a number (1 to 11) using the buttons.</p> <p> SSID: Specify a desired character string (1 to 32 characters). [: Move left or right one character.] ↔ [to] : Set a character.]</p> <p> Encryption: On Off </p> <p> WEP key: Specify a desired character string. (5 to 13 characters, or 10 to 26 digits in hexadecimal notation) [: Move left or right one character.] ↔ [to] : Set a character.]</p> <p> DHCP: Use Not use </p> <p> IP address: Enter using the numeric keys of the remote control. [: Move left or right one character.] ↔ [to] : Set a character.]</p> <p> Subnet mask: Enter using the numeric keys of the remote control. [: Move left or right one character.] ↔ [to] : Set a character.]</p> <p> Gateway: Enter using the numeric keys of the remote control. [: Move left or right one character.] ↔ [to] : Set a character.]</p> <p>Confirm: [OK] [Cancel] → [Apply:]</p>
Setting initialization	Reset all the network settings. Confirm: [OK] [Cancel] → [Apply:]
Projector name	Specify a desired character string (0 to 8 characters). [or : Enter setting mode.] → [] : Select item.] → [] : Move left or right one character.] → [to] : Set a character.] Confirm: [OK] [Cancel] → [Apply:]
Remote control	Specify whether to allow the remote control of the projector from a computer. Allowed Presentation Forbidden Allowed: The projector always accepts remote commands from a computer. Presentation: Accepts only the remote commands from the computer whose screen is currently displayed via the projector (Update automatically) using Wireless Utility. Forbidden: Always ignores any remote commands from a computer.
WEB browser	<p> Browser authentication: Switch on/off the password authentication for access to the setting screen using the Projector Configuration Tool. On Off </p> <p> Password: Enter the password used to access the setting screen when the Browser authentication is set to On. A character string (1 to 8 characters) can be specified as desired. [: Move left or right one character.] → [to] : Set a character.]</p> <p>Confirm: [OK] [Cancel] → [Apply:]</p>

* To enter characters, use the numeric keypad on the remote control.

● Details on individual items

• [Easy Connect (USB)]

This feature allows users to easily connect the projector to a computer over wireless networks, without making **network settings** via **Wireless Utility**.

• [Network settings]

<Mode>

Your projector is set to **Ad hoc** in the factory. Change the setting if you want to use the projector in **Infrastructure** mode.

<Channel>

Usually, you do not have to set this item. If a network group having the same **SSID** already exists in the projector's coverage, the channel is changed automatically to the channel of that network group.

Note 1: If a set channel is in bad connections for wireless connection, try the other channels to avoid the effects of radio waves to select the one in possibly the best communication conditions.

Note 2: To communicate in Ad hoc mode with a computer that cannot change the channel, start up the projector before the computer.

<SSID>

This is an ID code for connecting to specific individuals over a wireless LAN. This may also be called "**Network group**" or "**Network name**". Please read the following carefully.

Note 1: The **SSID** is set to **TDPJ** when shipped from the factory. If you leave this setting as it is, security may be compromised due to access by a third party using the "**Wireless Utility**" within the projector's possible communication area. Before using the projector, therefore, be sure to set **SSID** to a character string different from the default.

Note 2: When you use the Ad hoc communication mode, if there is a similar **SSID** network group (for example TDPJ, TDPJ1, TDPJ2, etc.) in the possible communication area, it is possible that your projector name will not be displayed in the **Wireless Utility** projector list column. If this is the case, set **SSID** to a completely different character string.

<Encryption>

Enable or disable encryption for security purposes.

Note: **Encryption** is factory-set to **Off**. If you use the projector with this setting left unchanged, security may be compromised due to access by a third party using the Wireless Utility within the projector's coverage. Before using the projector, therefore, be sure to set **Encryption** to **On**.

<WEP key>

When you have set **Encryption** to **On**, the **WEP key** must be set. For use at an encryption level of **64-bit**, specify a string of 5 arbitrary characters or a string of ten characters in hexadecimal notation. For use at the **128-bit** level, specify a string of 13 arbitrary characters or a string of 26 characters in hexadecimal notation.

Note: Alphabetic characters (A to F, a to f) used in hexadecimal notation are case insensitive; the uppercase characters and their lowercase equivalents are handled to be identical.

Setting up the wireless LAN (Continued)

The higher the number of bits, the stronger the encryption, and hence the harder it will be for a third party to decipher your communications. However, setting higher encryption levels may slow down communication speed. To set the highest security level, specify a **128-bit WEP** key. For higher security, avoid using a word found in a dictionary and change the key sometimes.

Set the following item if you have set the communication mode to Infrastructure.

<DHCP>

If you set **DHCP** to **Use**, the IP address of the projector is assigned automatically by the DHCP server. If your network environment does not assign IP addresses automatically, set **DHCP** to **Not use**, then set the following items **IP address**, **Subnet mask** and **Gateway** manually.

<IP address>

When **DHCP** is set to **Not use**, consult with your network administrator for the settings below and set the **IP address** manually.

An IP address is a unique number assigned to a terminal for connection to the Internet. The format is a string of four dot-separated three-digit numbers. (Example:

111.112.xxx.xxx)

<Subnet mask>

A subnet mask is used to determine what subnet the IP address assigned to a terminal belongs to. (Example: 255.255.xxx.xxx)

<Gateway>

This value specifies the device, such as a router, to be used to access servers outside the network. It is identified by the IP address. (Example: 111.112.xxx.xxx)

• [Setting initialization]

This item resets the wireless LAN settings to their factory defaults.

• [Projector name]

This can be used to identify projectors when communicating with multiple projectors, or if there is a possibility that another person who is out of communication range will be using the same projector. It is recommended this is set to prevent wrong transmission.

■ Note

- XXXXXXTR-21-2.

• [WEB browser]

<Browser authentication>

Browser authentication and Password are factory-set to Off and no string, respectively. You should set them as soon as possible.

<Password>

If you have forgotten your password, set it again using the menu on the main unit.

■ Computer settings

Refer to instruction manuals of your computer or wireless LAN PC card to perform the following settings.

- Select **Ad hoc** (for some PC cards, this is **Peer-to-Peer Group**).
- You may need to set channels depending on the wireless LAN PC card being used. Make the [**Channel**] settings identical to the computer settings.
- Set **SSID** (for some types of PC card, use **Network name** instead) as the same as projector's **SSID** (at factory shipment, this is set to **TDPJ**).
- If **Encryption** and **Key** are set on the projector, set to the same values.

■ Note

- The Config Free utility allows users to easily connect the projector to a computer over wireless networks, without making network setting. For Config Free support, the computer requires a wireless LAN environment that is NDIS5.1 compliant. Refer to the user's manual supplied with the wireless LAN adapter or the wireless LAN embedded computer for more information.

Projecting images stored in a memory PC card or USB memory

This projector can read JPEG files stored in a memory PC card or USB memory and display them on the screen.

This allows you to give presentations without a computer, create an advertising screen board using the slideshow function, and more. (The projector cannot reproduce animation effects such as those produced by Microsoft® PowerPoint®.)

■ Memory PC cards

● PC card slot types

The PC card slot installed on this projector is TYPE II (PCMCIA Release 2.1)-compliant. Please use memory PC cards and conversion adapters compliant with this type of PC card slot.

Only a 3.3-V PC card can be used. (A 5-V only PC card cannot be used.)

● Supported storage media types

This projector supports the following types of ATA-compliant storage media. This owner's manual refers to the combination of the ATA conversion adapter and media in use as a "memory PC card."

Storage media that can be used as-is

Flash ATA card, TOSHIBA Mobile Disk

Storage media that can be used in combination with each of the ATA conversion adapter types

SmartMedia™, CompactFlash card, SD memory card, miniSD card, MMC, memory stick, xD-Picture Card™

Note that inserting conversion adapters and memory cards with different functions than above, and other memory cards (excluding the supplied wireless LAN PC card) into the projector could damage the PC card or cause malfunctions.

● Memory PC cards whose operation has been verified

Please note that presence on this list is not a guarantee of operation.

- TOSHIBA Mobile Disk: PAMHD005 (5GB), PAMHD002 (2GB)
- SmartMedia™: TOSHIBA PDR-SM32 (32MB), PDR-SM64 (64MB)
- SD memory cards: TOSHIBA SD-M512 (512MB), SD-M256 (256MB), SD-M128 (128MB)
- miniSD cards: TOSHIBA SD-S64 (64MB), SD-S32 (32MB)
- Adapters: BUFFALO MCR-5A, RXD-A

The TOSHIBA IPC5019A SmartMedia™ PC card adapter is not ATA-compliant, and so cannot be used by this projector.

■ USB memories

● The USB terminal

The USB terminal of the projector is USB2.0 compliant and can connect with a USB memory, a USB memory card reader/writer, a digital camera and the like.

● USB devices whose operation has been verified

Toshiba does not guarantee the operation of all USB devices.

- Toshiba USB memory : U2A series (64MB, 128MB, 256MB, 512MB)
- Toshiba USB memory : U2B series (128MB, 256MB)
- SanDiskUSB memory : SDCZ2 series (128MB, 256MB, 512MB, 1GB)
- SanDiskUSB memory : SDCZ4 series (128MB, 256MB, 512MB)
- Toshiba USB card R/W : IPCS078A
- SanDiskUSB card R/W : SDDR-88-J70

This projector does not support Toshiba IPCS060A series USB memory.

Note that this projector does not support all USB memories, USB card readers/writers, and digital cameras.

■ Backing up data

Toshiba recommends that you back up the data saved in the memory PC card, the USB memory, and in the memory card before use. (Toshiba assume no liability for losses incurred by data lost through the use of this projector.)





















■ JPEG files

- (1) Supported file extensions are jpg, JPG, jpeg, and JPEG.
- (2) The maximum number including both folders and files is 512.
- (3) Some JPEG files are not supported by this projector.

The limitations in (3) above can be alleviated by converting the JPEG file with the supplied **JPEG Conversion Tool** [v.71](#) software application.

■ Setting slideshow options

Slideshow is the function to display the JPEG image files stored in a memory PC card or a USB memory one after another at fixed time intervals. When switching from one image to the next, Slideshow can add various display effects (transitions) to them. If you select **Slideshow**, the following items can be set.

Item  	Description
 Auto. demo	On  Off (Select whether to automatically start a slide show when a PC card is plugged.)
 Interval	Select the slide show display interval.  or  : Begin a slide show. Use the   buttons to select. 5 sec./10 sec./30 sec./1 min./3 min./5 min./10 min.
 Transition	Select the slide show display effect.  or  : Begin a slide show. Use the   buttons to select. None / Wipe ↑ / Wipe ↓ / Wipe ← / Wipe → / Dissolve / Cover ↑ / Cover ↓ / Cover ← / Cover → / Checker / Zoom / Rotate zoom / Belt wipe / Blind
 Play icon	Standard  Continuous
 Thumbnail preview	Switch the form of thumbnail preview. All  File  Off
 Unplug device	Run when unplugging a USB device. Confirm: Yes  No

● Details on individual items

• [Auto. demo]

On: A slide show begins automatically when a memory PC card is inserted and input switches to Wireless/Card. At this time, the JPEG files in the root directory of the memory PC card are used in the slide show. If the input has already been switched to Wireless/Card, the slide show begins automatically when the memory PC card is inserted.

The Auto Demo function is also available with a USB device.

- To pause the slide show, press the  button. Pressing this button again allows the slide show to begin. To stop the slide show, press the **RETURN** button.

Off: A list of thumbnails will be displayed when connecting with a memory PC card, a USB device or the like. Select a desired JPEG file from the list.

■ Note

- The Auto Demo function does not work when using a USB memory card reader to mount multiple media.

• [Interval]

You can set the display interval of time (in seconds or minutes) for slide shows to be played automatically.

• [Display effect]

When playing a slide show, the projector can give various display effects or transitions to each slide being displayed.

The transitions available are listed below:

• None

Display each slide normally.

• Wipe

Display the next slide gradually upward (Wipe ↑), downward (Wipe ↓), to the left (Wipe ←), or to the right (Wipe →), over the current slide.

• Dissolve

Display the next slide gradually in a certain fixed block pattern over the current slide.

• Cover

Display the next slide as sliding upward (Cover ↑), downward (Cover ↓), to the left (Cover ←), or to the right (Cover →), over the current slide.

• Checker

Display the next slide gradually from the left using checkered blocks over the current slide.

• Zoom/Rotate zoom

Display the next slide by enlarging it gradually, either straight from the center (Zoom) or while turning it starting from the center (Spin zoom), over the current slide.

• Belt wipe

Display the next slide gradually in stripes from both sides, over the current slide.

• Blind

Display the next slide, as if it opened like a window blind, over the current slide.

• [Play icon]

The slideshow icon can be displayed.

• Standard

The projector handles the slideshow icon as follows depending on the “On/Off” setting of **Icon** on the projector’s menu.

Icon On: The projector displays the icon upon the start of playing a slide show and turns it off after a few seconds.

Icon Off: The projector does not display the icon.

• Continuous

The projector keeps the icon displayed during the slide show.

• [Thumbnail preview]

Select the form of thumbnail preview.

All: Displays a thumbnail preview of JPEG files, and if any JPEG files exist in the folder displays the leading thumbnail image.

File: Displays only a thumbnail image of JPEG files. The thumbnail image of the JPEG files in the folder is not displayed.

Off: Displays a dummy icon without displaying thumbnail preview.

• [Unplug device]



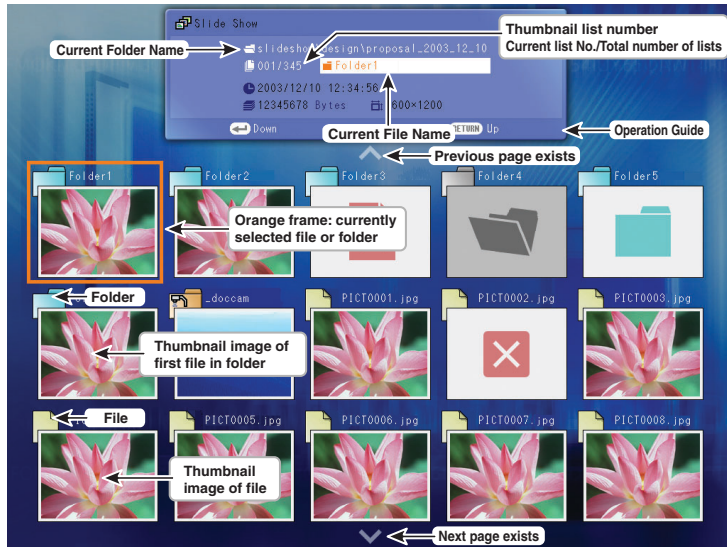

Run when unplugging a USB memory, a USB memory card reader or a digital camera and the like.

■ Playing a slide show from a thumbnail list

With [Auto. demo] set to [Off] in “Setting slideshow options”, data readout begins when a memory PC card or USB device is inserted and the input switches to Wireless/ Card or USB memory. A list of thumbnails will then appear on the screen. The figure below is an example of this process:



Symbols in the thumbnail list

- | | | | |
|---|---|---|--|
|  | Indicates that only folders are inside the folder. |  | Indicates that there is no data to be displayed in the folder. |
|  | Indicates that the JPEG or other file is not supported. |  | Indicates that an unsupported JPEG or other file is present. |
|  | When the Thumbnail preview is set to Off, the screen appears like this. | | |

● Playing a slide show from a thumbnail list





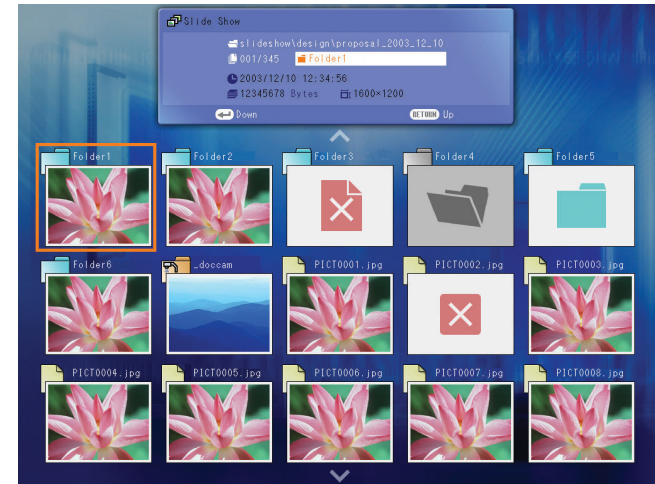

1 Plug a memory PC card.

Plug a memory PC card into the PC card slot according to the procedure in “Mounting a PC card” p.23 .



The projector starts loading data from the memory PC card and displays a thumbnail list on the screen.





2 Searching for a target file



- Use the     buttons to move the orange frame over the desired file or folder.
- If there are multiple pages of thumbnails, click the  button on the bottom row to go to the next page, and the  button on the top row to go to the previous page.
- To open a folder, move the orange frame to the desired folder and press the  button. You can navigate down up to 5 levels using the same procedure. Pressing the **RETURN** button returns you to the next or other upper level folder.

3 Displaying slides

- Pressing the  button with a file selected displays the image in that file only in full-screen view on the screen as a slide. Pressing the  button enters the automatic play mode.
- To return to the thumbnail list display screen, press the **RETURN** button.

4 Changing slides

Pressing the   buttons with a slide displayed changes slides.

(: previous slide; : next slide. These buttons are not available during an automatic play.)

Projecting images stored in a memory PC card or USB memory (Continued)

5 Rotating a slide

Pressing the ▲ ▼ buttons with a slide displayed rotates the slide 90 degrees. The rotation information is preserved as long as you remain in the current folder.

(▲: Rotate left; ▼: Rotate right. These buttons are not available during an automatic play.)

Notes

- The thumbnail display order and slide order goes in order from shortest file name to longest. If two file names have the same number of characters, they are ordered numerically if numbers are used in the file name, and alphabetically otherwise.
- It is possible to give presentations without using a computer by converting presentations created with Microsoft® PowerPoint® into JPEG files using the **JPEG Conversion Tool**, and storing them on a memory PC card. [p.73](#)
Note, however, that functions such as animation effects and hyperlinks cannot be used, so it should be tested before the actual presentation.
- Freeze function can not be used during slide show or automatic play.

Checking the projector status

■ Status display

To check the current status of the projector, select **Status display** in step 2 in “**Projector settings**” [p.52](#). The following items of information will then be displayed.

Application	The name of the application currently running on the projector is displayed. (Examples: Slideshow, Wireless Utility)
Device	When no device is plugged “Type” is displayed. When a memory PC card or USB memory is plugged “Type/Free space/Status” are displayed. When a wireless LAN PC card is plugged “Type/MAC address/Mode/Channel/SSID/Encryption/IP address/ Subnet mask/Gateway” are displayed.
Version	The firmware version number of the wireless/card feature or the USB memory feature is displayed.

■ Note

- This product contains a piece of software (hereafter the Software) licensed to TOSHIBA CORPORATION (hereafter TOSHIBA) by AXE, Inc. (hereafter AXE). The copyright and other intellectual property rights of the software are held by AXE or the licensor. The software is protected by the Copyright Law, Universal Copyright Convention, and other intellectual property laws and agreements. The permission of AXE or the licensor must therefore be obtained before the software can be reproduced. Note, however, that the software is partly covered under the GNU General Public License Version 2 (hereafter GPL2). You can obtain a copy of GPL2 at <http://www.fsf.org/copyleft/gpl.html>. AXE will provide the GPL-covered source code of the software in accordance with the terms of GPL2. Contact AXE if you need it.

An OS of axLinux is a registered trademark of AXE, Inc.

Installing the applications

If you will use the wireless LAN PC card function, install the application on the supplied CD-ROM onto your computer.

■ System Requirements

Supported OS: Windows® 2000, Windows® XP
CPU: Pentium M 1 GHz or higher recommended
RAM: 256 MB or more recommended
Screen area (resolution): 1024 by 768 pixels recommended

■ Application Types and Major Functions

Wireless Utility

This application is used for wireless connections. Use it to send the images from the computer's screen to your projector, and display on the screen.

JPEG Conversion Tool

Use to convert JPEG and other files into a format that can be displayed as a slide show using a memory PC card.

■ How to install

In the supplied CD-ROM, select the **Wireless Utility** folder, and run **setup.exe**. Follow the instructions on your computer screen.
During the installation, a dialog box may appear with the message “**Digital Signature Not Found**” and the prompt “**Do you want to continue the installation?**”. Click on the [Yes (Y)] button to continue the installation.
When installation is finished, the following shortcuts will appear on your computer's desktop:

Wireless Utility →  Operations [p.66](#)

JPEG Conversion Tool →  Operations [p.71](#)

■ How to uninstall

Select [Start Menu] → [Settings] → [Control Panel] → [Add/Remove Programs], and remove **Toshiba Data Projector** from currently installed programs.

■ Notes

- Before beginning installation or uninstallation, you need to log on as Administrator.
- Your computer screen may temporarily go out during installation, but it is not an errors.

Using the Wireless Utility

■ Displaying a computer's screen via the projector

① Launch the Wireless Utility software application.

When the **Wireless Utility** launches, the **Screen Image** transmission mode window appears on the computer screen.

To switch to the **Screen Image** transmission mode window from another mode, click on the **Screen Image** icon .



② Select Transmission mode.

Click on **Update automatically** or **Update manually**. See step ⑥ for the meanings of **Update automatically** and **Update manually**.

③ Click on the Advanced button.

The **Screen Image: Advanced Settings** dialog appears. Set the dialog as shown below, as necessary.

• Interruption

Check the **No Interruptions** checkbox to prevent other computers from interrupting the projector, for example, during presentation in the **Update automatically** mode.

• Window

Select the **Place in Tasktray at the start of transmission** checkbox to iconify the **Wireless Utility** and place it in the computer's tasktray when transmission initiated.

To display the window, double click on this icon, or right click and select **Open** from the popup menu. Even with the **Wireless Utility** window minimized, you can use the pop-up menu to stop or resume transmission as described in step ④ and later

• Mode

Selecting **High quality** improves the quality of the projected image, but lowers communication speed. Selecting **High speed** has the opposite effect.

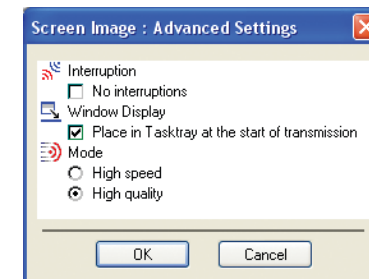

Using the Wireless Utility (Continued)

4 Select the screen image you wish the projector to display.

Select Desktop

The computer screen image is transmitted as-is.

Select application window

Select a running application (e.g. Microsoft® PowerPoint®), and send that application's window only.

The desktop and a list of running applications are displayed. Select the desired application from this list. (If the desired application is not on the list, launch it. Note that if too many applications are running, it will consume the computer's resources, which could slow communication speed.)

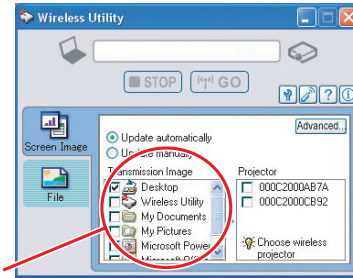

5 Select the projector to be transmitted.

The IDs of projectors accessible for communication will be listed. (When a projector name is set, that name appears instead of MAC address.) Select the checkbox of the projector you wish to transmit to from this list. Then icon  is displayed on the projector's screen for few seconds.

It is possible to select up-to four projectors.

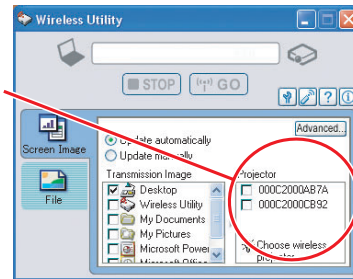

6 Click on the button.

When "Update automatically" is selected in step 2

Screen images are sent consecutively after the  button is clicked.

When "Update manually" is selected in step 2

A single screen image is sent when the  button is clicked.

7 To halt transmission from Update automatically, click on the button.

If the **Wireless Utility** icon has been placed in the tasktray, double click on the icon to display the window, then halt transmission, or right click on the icon, and halt transmission.

Notes

- It may not be possible to transmit the images from movie player or other video applications.
- When using "Update automatically", the transmitted image refresh rate depends on the performance of the computer you are using and the surrounding radio wave environment.
- The projector screen may have a few differences from the computer screen.
- It is not possible to transmit to a projector that is already receiving from another computer.
- If you selected application window in step 4, if that application is not active (in use), the image may not be correctly displayed by the projector.
- The projector ID is the MAC address of the wireless LAN PC card inserted into the projector.

■ Displaying a JPEG image saved on a computer via the projector

1 Launch the Wireless Utility software application.

The **Screen Image** transmission mode window appears on the computer's screen.

2 Click on the File icon .

The **Wireless Utility** window changes to **File** transmission mode.

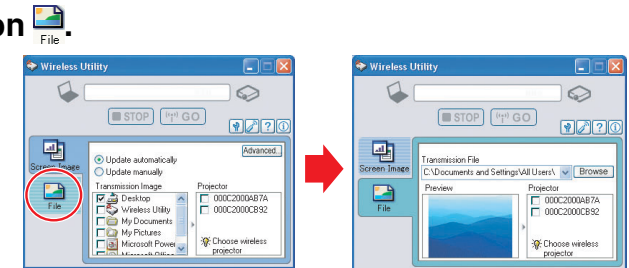

3 Click on the Browse button, and select the file to send.

Clicking on the **Browse** button displays the **Open** dialog box. Select the file to send, then click on the **Open** button.

The selected file is added to the pull-down list in the **Wireless Utility's Transmission File** field.

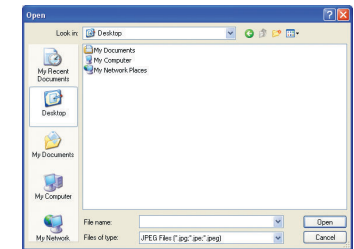

4 Select the file to be sent from the pull-down list of the Transmission File field.

Click on the **Transmission File** field's  button to display the pull-down list. Select the file to be sent from this list.

A thumbnail of the selected file appears in the **Preview** box. The file displayed here will be transmitted.

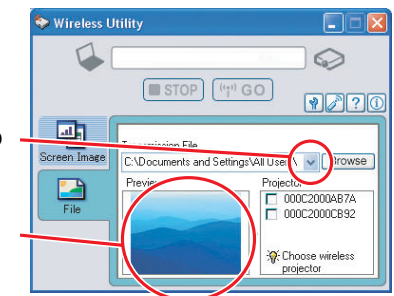

Step 3 can be skipped.

The way that drag and drop the file to be sent from the desktop or Windows Explorer into the **Preview** box is also available. In this case as well, the selected file is added to the file pull-down list **Transmission File** field's.

Using the Wireless Utility (Continued)

5 Select the projector to be transmitted.

The IDs of projectors accessible for communication will be listed. (If projector name has been set up already, it is shown instead of the MAC address.) Select the checkbox of the projector to be transmitted to from this list. Then icon  is displayed on the projector's screen for few seconds. It is possible to select up-to four projectors.

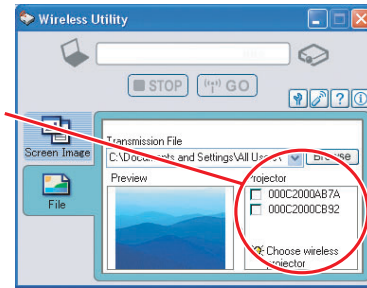

6 Click on the button.

The selected file's image is displayed by the projector.

Note

- Only one file can be sent at a time. To send another file, repeat steps 4 and 6.

Easy Connect utility

This feature allows users to easily connect the projector to a computer over wireless networks, without making network settings via Wireless Utility.

Launch the Wireless utility software application and click the Tool button (icon) to bring up the Wireless LAN utility dialog box. Select a desired connection mode in this dialog box.

How to set up a simple 1:1 connection

Setting on the projector

- 1 Turn the projector power on.
- 2 Insert the supplied wireless LAN PC card to the PC card slot.
- 3 Switch the input to Wireless/Card.
- 4 Press the  button on the projector control panel.

Setting on the computer

1 Launch the Wireless Utility software application.

When the Wireless Utility launches, the Screen Image transmission mode window appears on the computer screen.

2 Click the Tool button .

The Wireless LAN Setting Utility dialog box appears.



3 Select Simple 1:1 connection then click OK.

The connection starts up. When a connection confirmation message appears, proceed as instructed in the message.

4 The projector name of the connected projector or the MAC address of the wireless LAN PC card is displayed.

Notes

- This operation is allowed only when the Transmission mode is set to Ad hoc in the projector network settings.
- The operation procedure of the projector setting and the computer setting can be altered without affecting the connection setup, assuming the operation on each side is complete within 60 seconds.

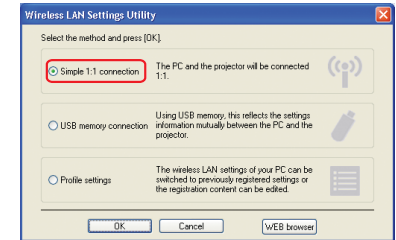

How to connect USB memory

Set up wireless LAN using a commercial USB memory. See [p.57> for available USB memories.

Copying the computer settings to the projector

Setting on the computer

1 Plug the USB memory into the computer.

2 Click the button of the Wireless Utility to bring up the Wireless LAN Utility dialog box. Select Connect USB memory and click OK.

The dialog box for USB memory connection appears.

3 Select how to create the setting information then click OK.

- Copies the settings information of the current PC.
- Creates the settings information manually.

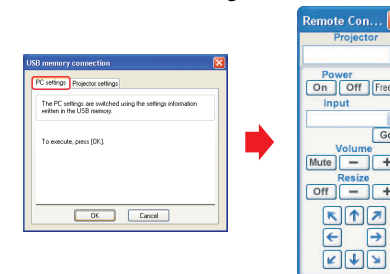

The setting information is saved to the USB memory.

Using the Wireless Utility (Continued)

4 Unplug the USB memory from the computer.

To unplug the USB memory, follow the instructions in the user's manual supplied with the USB memory or the computer.

• Setting on the projector

- 1 Turn the projector power on.
- 2 Insert the supplied wireless LAN PC card to the PC card slot.
- 3 Switch the input to Wireless/Card.
- 4 Plug the USB memory into the projector.

A message appears, notifying that the projector settings have been changed.

- 5 When the setting is complete, the connection is established. The projector name of the connected projector or the MAC address of the wireless LAN PC card is displayed.

Copying the computer settings to the projector

• Setting on the projector

- 1 Turn the projector power on.
- 2 Insert the supplied wireless LAN PC card to the PC card slot.
- 3 Switch the input to Wireless/Card.
- 4 Plug the USB memory into the projector.

A message appears, notifying that the projector settings have been changed.

- 5 Select **Config free (USB)** in **Wireless Utility settings** from the **Wireless/ Card** menu and press the **OK** button.
- 6 When a confirmation window appears, click **Yes** then press the **OK** button.

The network settings are saved to the USB memory. When successfully saved, a message appears.

- 7 Unplug the USB memory following the instruction in [p.49](#).

• Setting on the computer

- 1 Launch the **Wireless Utility software application**.
- 2 Plug the USB memory into the computer.
- 3 After a confirmation message appears, make settings.

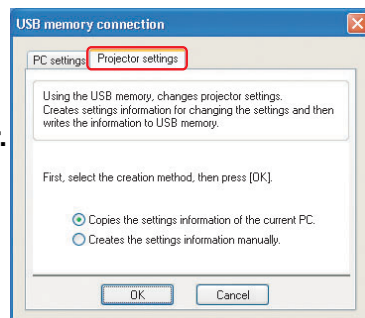

- 4 When the setting is complete, the connection is established. The projector name of the connected projector or the MAC address of the wireless LAN PC card is displayed.

This operation is allowed only when the Transmission mode is set to Ad hoc in the projector network settings.

• Profile

This feature allows the user to save the computer settings.

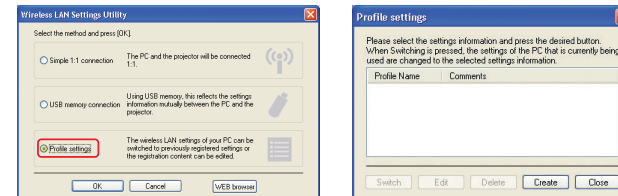

• Web browser

Where the computer and the projector are connected over wireless LAN, bring up the window of Projector Configuration Tool by pressing the Set browser button.

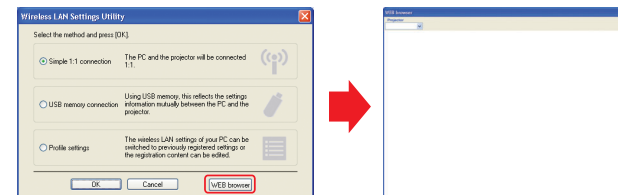

■ Precautions

- If the page is not displayed correctly, re-select the projector.
- When the network settings are changed, the network connection is disconnected. If you wish to reconnect, set up the computer again.

■ Precaution

- The simple 1:1 connection, the USB memory connection and the profile setting may not work normally depending on the type of the wireless LAN PC card and the wireless LAN embedded computer. When such a case arises, use the Wireless Utility menu to make network settings manually.

■ Operating the projector

This function can be used with any projector input.

Note, however, that this will not function with a memory PC card.

- 1 Launch the **Wireless Utility software application**.

The **Screen Image** transmission mode window appears on the computer's screen.

Using the Wireless Utility (Continued)

2 Click on the Remote Control button.

The **Remote Control** window appears.

As the **Wireless Utility** window is still displayed, you can operate the projector via the **Remote Control** window, while using the **Wireless Utility**'s functions.

While it is possible to use this function merely to operate the projector, closing the **Wireless Utility** also closes the **Remote Control** window.

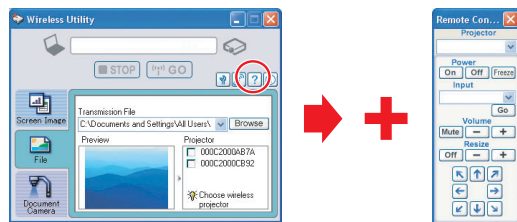

3 Select the projector to be operated.

In the **Remote Control** window, click on the  button, and select the desired projector from the pull-down list.

Only one projector can be selected. (It is not possible to operate multiple projectors.)



4 Click on the Remote Control window's buttons.

The function of each button and box is as follows:

Power On: Turns projector power on.

Power Off: Turns projector power off.

Freeze: The picture is paused.

Input (box): Click on the  button, and select the desired input from the pull-down list.

Go: Switches to the input selected in the Input box.

Mute: Cuts off picture and sound. Click again to restore picture and sound.

Volume +/-: Adjust sound volume.

Resize Off: Restores the picture to its original size.

Resize +/-: Adjusts the enlargement ratio.

 : Move screen (up/down/left/right/diagonal)

5 To quit, click on the button on the Remote Control window.

Performing this does not close the **Wireless Utility** window.

To exit both the **Wireless Utility** and the **Remote Control**, click on the  button on the **Wireless Utility** window.

How to use the JPEG Conversion Tool

The **JPEG Conversion Tool** converts JPEG files not supported by the projector, image files in other formats, Microsoft® PowerPoint® files, and the like into JPEG files supported by the projector. The JPEG files converted with this tool can be displayed by sending them using the wireless LAN PC card [p.68](#), or saving them on a memory PC card [p.58](#).

■ Launching the JPEG Conversion Tool

The window shown in the figure to the right appears on the computer screen.

Drag the **Image Quality Settings** slider to the left or right to set the image quality of the file after conversion. Lower values create smaller files, but lower the image quality. (It is not possible to restore the quality of an image after it has been lowered.)

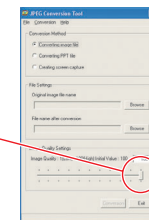

■ Converting an image file

This converts JPEG files using compression formats not supported by the projector, Windows® metafiles (wmf), and bitmapped files (bmp) into JPEG files.

- (1) In the **Conversion Method** field, select **Converting image file**. (Status on launch)
- (2) In the **File settings** field, click on the **Browse** button for **Original Image File Name**. The **Open** dialog box appears.
- (3) In the **Open** dialog box:
 - (a) Specify the location of the file to be converted; and
 - (b) In the **Files of Type** field, click on the  button to select the file format. A list of files of that format appear in the **Open** dialog box.
- (4) In the **Open** dialog box, select the file to convert, then click on the **Open** button.
- (5) In the **JPEG Conversion Tool** window, in the **File settings** field, select **Browse** for **File name after conversion**. The **Save As** dialog box appears.
- (6) In the **Save As** dialog box:
 - (a) Specify the location in which to save the converted file;
 - (b) Enter a file name of up to 8 characters in the **File Name** field; and
 - (c) Press the **Save** button.
- (7) (a) In the **JPEG Conversion Tool**, click on the **Conversion** button.
 - (b) A confirmation dialog box opens. Click **Yes**. The computer converts the file. When it finishes a message appears informing you that a "JPEG file has been created".

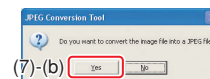
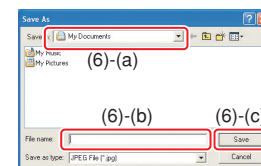
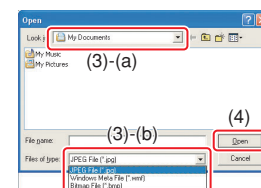
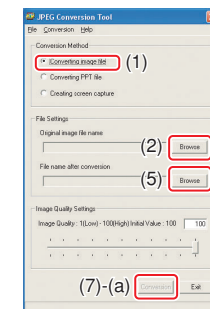

How to use the JPEG Conversion Tool (Continued)

■ Converting files created with Microsoft® PowerPoint®

This process provides presentations without using a computer by converting presentation files created with Microsoft® PowerPoint® into JPEG files, storing them on a memory PC card, and displaying them in a slide show.

- To use this conversion mode, Microsoft® PowerPoint® must be installed on the computer.
- Only static images are supported by this process. Animation and audio are not supported.

Presentation files created with Microsoft® PowerPoint® usually consist of several slides. For this reason, the tool creates a folder with the name specified in step (5), below, and file for each slide is created in the folder (starting with slide001.jpg).

- (1) In the **Conversion Method** field, select **Converting PPT file**.
- (2) In the **File settings** field, click on the **Browse** button for **PPT File Name**.
The **Open** dialog box appears.
- (3) In the **Open** dialog box:
 - (a) Specify the location of the file to be converted; and
 - (b) Select the PowerPoint® presentation file to convert, then click on the **Open** button.
- (4) In the **JPEG Conversion Tool** window, in the **File settings** field, click on the **Create** button for **New folder name**.
The **Folder create** dialog box appears.
- (5) In the **Folder create** dialog box, in the **Folder Name** of document field, specify a folder name of 12 characters or less.
- (6) In the **Folder create** dialog box, click on the **Selection** button.
The **Browse Folders** dialog box appears.
- (7) In the **Browse Folders** dialog box:
 - (a) Specify the location in which to save the folder; and
 - (b) Click on the **OK** button.
- (8) In the **Folder create** dialog box:
 - (a) Click on the **Create** button.
A confirmation dialog box appears;
 - (b) Click on the **OK** button.
- (9) (a) In the **JPEG Conversion Tool** window, click on the **Conversion** button.
(b) A confirmation dialog box opens. Click **Yes**.
The computer begins to convert the file. When it finishes, a message appears informing you that a “**JPEG file has been created**”.

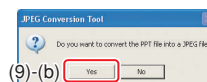
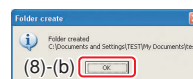
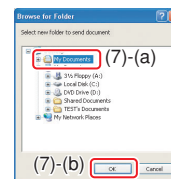
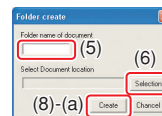
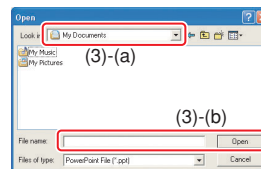
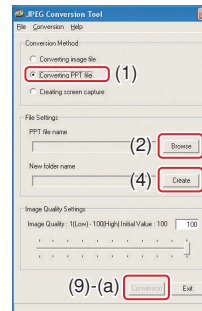

■ Making a presentation with converted JPEG files

- (1) Copy the folder created by the **JPEG Conversion Tool**, or its contents, onto a memory PC card.
- (2) Use the step ① in “**Playing a slide show from a thumbnail list**” p.61 to display a list of thumbnails.
- (3) Follow the instructions in step ② in “**Playing a slide show from a thumbnail list**” p.61 to find the thumbnail of the first slide, Slide001.jpg, and move the orange frame to it. (Select Slide001.jpg)
- (4) Press the ⏪ button on the remote control. An enlarged view of the first slide appears on the screen. This starts the presentation.
- (5) To continue to the next slide, click on the remote control's ⏩ button. To go back to the previous slide, click on the ⏮ button.

■ Creating a screen capture and converting it into a JPEG file

This function saves the current computer screen as a JPEG file.

- (1) In the **Conversion Method** field, select **Creating screen capture**.
- (2) In the **File settings** field, click on the **Browse** button for **File name after conversion**.
The **Save As** dialog box appears.
- (3) In the **Save As** dialog box:
 - (a) Specify the location in which to save the converted file;
 - (b) Enter a file name of up to 8 characters in the **File Name** field; and
 - (c) Click on the **Save** button.
- (4) (a) In the **JPEG Conversion Tool** window, click on the **Conversion** button.
(b) A confirmation message appears. Click **Yes**.
The computer creates a screen capture, and converts it into a JPEG file in the specified location. When it is finished, a message appears to tell you that a “**JPEG file has been created**”.

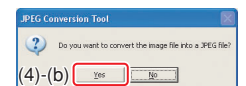
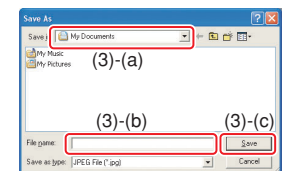
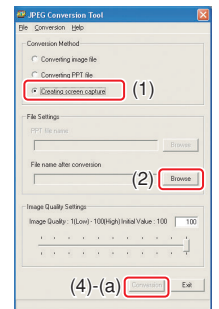

■ Note

- The maximum resolution of JPEG files created with the **JPEG Conversion Tool** is 1,024 × 768 pixels.

Setting up the projector using a Web browser

■ How to use the “Projector Configuration Tool”

The “Projector Configuration Tool” uses the Web server features of the projector to set up the projector using a wireless LAN PC card.

When using the “Projector Configuration Tool”, set up the wireless LAN connecting the projector and the computer.

1 See “Checking the projector status” p.64 to display information on the screen and write down the IP address.

2 Invoke Internet Explorer.

Internet Explorer Ver. 6.0 or later is recommended. Enable the Javascript functions.

3 In the address bar, enter the IP address “http://xxx.xxx.xxx.xxx/” recorded in step 1 above.

The Web browser will then display the following page.

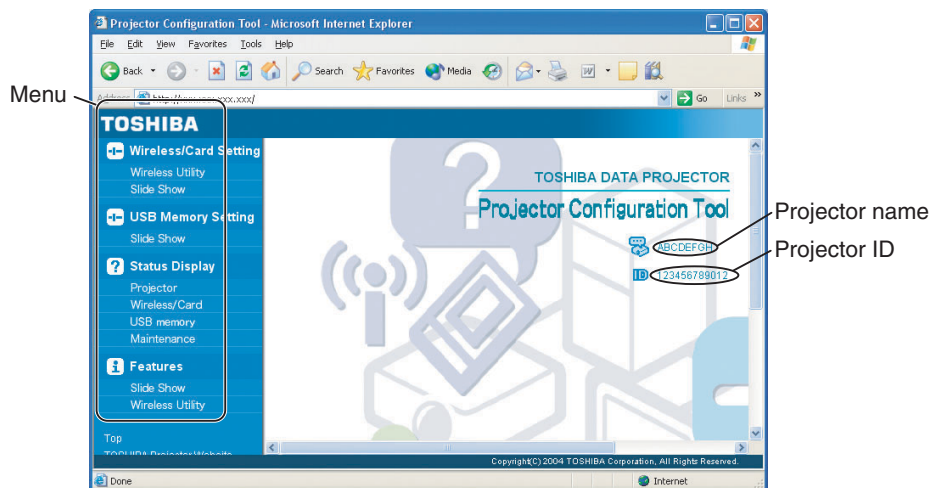

Note 1: To prevent access from third parties, the projector is restricted to permit access only from the computer that has been set up for the TCP/IP to have the same network address as the projector.

Note 2: If you use a proxy server, do not enable the proxy when accessing the above IP address.

When the wireless LAN is set to use Ad hoc mode, use the WEB browser setting function in the Config Free menu of Wireless Utility.

■ Note

- This function can be enabled using the **WEB Browser** settings function in the Config free menu of Wireless Utility without specifying the URL into the browser's address bar.

4 Select items from the menu on the left.

Wireless/Card Settings: Make settings for the Wireless/Card input menu.

USB Memory Settings: Make settings for the USB memory input menu.

Status Display: Verify the projector state.

Features: Shows the functions available with the Wireless/Card and USB input menus.

Top: Returns you to the top page.

TOSHIBA Projector Site: The browser will display the home page at <http://multimedia.projector-toshiba.com/map.html>, providing projector information. The home page address is subject to change without notice.

(The Toshiba's web site can be browsed only when your computer can access the Internet.)

● Details on major items

● Wireless/Card Settings

When **Browser authentication** has been set to **On**, access to the setup page requires the input of the password.

Wireless Utility: The items displayed on the screen can be set. Entering individual items and press the **Execute** button to update their setting. Note, however, that security items such as “**Remote control**” and “**Browser authentication**” cannot be set.

Slide Show: The items displayed on the screen can be set. Entering individual items and press the **Execute** button to update their setting.

● USB Memory Settings

When **Browser authentication** has been set to **On**, access to the setup page requires the input of the password.

Slide Show: The items displayed on the screen can be set. Entering individual items and press the **Execute** button to update their setting.

● Status display

Displays some states of the projector.

Projector: Displays the contents of status display in the menu.

Wireless/Card: Displays the contents of status display of the Wireless/Card input.

USB Memory: Displays the contents of status display of the USB memory input.

Maintenance: Describes an error if it occurs, for example, when the lamp has blown.

■ Note

- Clicking the ? button opens a popup help window.

About lamp

The product's light source is a mercury lamp that lights at increased internal pressure. Be sure to fully understand the following characteristics of the lamp and handle it with extreme care.

- The lamp may burst with a loud noise due to impact or deterioration, or fail to light at the expiration of its life.
- How long it takes before the lamp bursts or the life expires may vary greatly by lamp. Some may burst shortly after first use.
- Burst is likely to happen if the lamp is used after the replacement period has elapsed.
- When the lamp bursts, the broken pieces of glass may get inside the product or be released outside from the openings for ventilation.
- When the lamp bursts, a slight amount of mercury gas enclosed in the lamp along with glass dust may be released from the openings for ventilation.

■ Immediately replace the lamp when a sign appears on the screen.

- When the replacement time approaches, a message will appear on the screen.
- The risk of burst will increase if the lamp is continuously used without being replaced.
- Frequently check the used hours and prepare spares when the replacement time approaches. (Refer to "Status display". [p.48](#))

■ When the lamp is broken

- If glass components, including a lamp and a lens, should break, handle the broken pieces with care to avoid injury and contact your dealer for repair service.
- In the event of lamp burst, unplug the product from the wall outlet, leave and completely ventilate the room. Then, thoroughly clean the area around the projector and discard any edible items placed in that area.
- When the lamp bursts, consult a doctor if glass dust or mercury gas gets into your eyes or you breathe it.

Lamp replacement

A lamp is consumable supplies. If used for extended periods, images will appear dark, and the lamp could burn out. This is characteristic of a lamp, and is not malfunction. (The lifetime of the lamp depends on condition of use.) If this happens, replace it with a new one.

⚠ WARNING

- If the projector is mounted on the ceiling, it is recommended to use your Toshiba dealership when the lamp has to be exchanged.
- Uncovering the lamp while the projector is mounted on a ceiling may lead to a danger of damage from falling pieces of glass if the lamp is broken. Besides, working at high elevations can also be hazardous. Do not attempt to replace the lamp by yourself.
- When replacing, always use lamp "TLPLW6" (sold separately).

⚠ CAUTION

- If you have been using the projector, the lamp will be very hot, and may cause burn injuries. Wait for the lamp to cool (for longer than 1 hour) before replacing it.
- If the lamp should break, please handle with care to avoid injury due to broken pieces and contact your dealer for repair service.

Lamp replacement (Continued)

1 Unplug power cord.

2 Wait until lamp is sufficiently cooled.

Wait for at least 1 hour.

3 Remove the outer lamp cover.

Loosen the two screws, raise the outer lamp cover with your fingers as shown to remove the outer lamp cover. Use care to avoid any damage to nails and/or tip of your finger(s). If you have any difficulty in removal, you can use a screwdriver or any other smaller tool for your convenience.

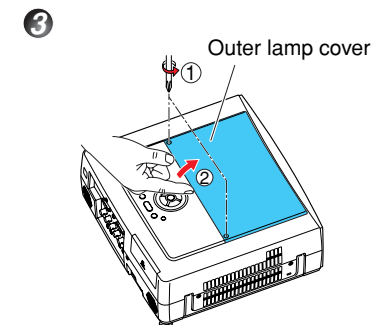

4 Remove the inner lamp cover.

Loosen the screw to remove the inner lamp cover.

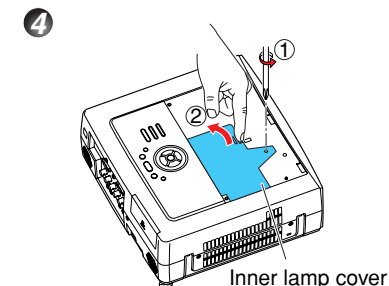

5 Pull out the lamp.

Loosen the three lamp locking screws, pull up the handle, and press the tab to remove the lamp.

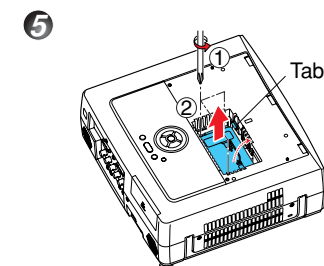

6 Mount the new lamp.

Align the orientation, press down the new lamp until the bottom is reached, and lock in place using the three lamp locking screws.

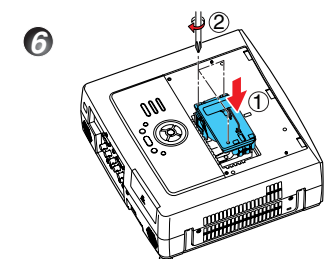

Lamp replacement (Continued)

7 Replace the inner lamp cover.

Tighten the screw loosened in step 6 until the inner lamp cover is no longer loose.



8 Replace the outer lamp cover.

Align the cover, and press it in, then tighten the screws loosened in step 6 until the outer lamp cover is no longer loose. (Be sure to replace the outer lamp cover.)

9 Reset the lamp timer.

See the lamp's manual for instructions on resetting the lamp timer.

Notes and Precautions

- Press the  button twice to display (a rough guide) the time of lamp use, the [Lamp time] item, in the **Status display** menu. [p.48](#)
- It is recommended that the lamp be replaced after 2,000 hours of use. When [Lamp time] reaches 2,000 hours, the  icon and a message will appear with a beep sound. (After 2,000 hours, they will appear when the power is on at the first time every 100 hours.) This display disappears when you press the  button.
- Attach the outer lamp cover correctly so that it is not loose. If it is not attached correctly, the projector may fail to be powered on or the lamp may fail to come on.
- Always replace the lamp with a new one.
- The lamp is made out of glass. Do not touch the glass surface with your bare hands, bang it, or scratch it. (Dirt, jolts, scratches and the like could break the lamp.)

Used Lamps

This projector's lamps contain trace amounts of environmentally harmful inorganic mercury. Be careful not to break used lamps, and dispose of them in accordance with local regulations.

Lens and main unit cleaning

WARNING

- Request cleaning and maintenance of a ceiling-mounted unit from your projector dealership. Attempting to clean/replace the lamp at a high site by yourself may cause you to fall down, thus resulting in injury.

■ Lens cleaning

- Clean the lens with a commercially available blower and/or lens cleaner.
- The lens is easily scratched, so do not rub it with hard objects, or strike it.

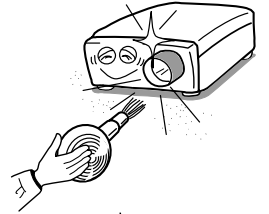

■ Main unit cleaning

- Clean the main unit after unplugging the power cord.
- Wipe dirt off the main unit gently with a soft cloth.
- Do not wipe the main unit with a damp cloth. Doing so may allow water to get inside, resulting in an electric shock or failure.
- Do not use benzene, thinner and the like as they may deform or discolor the unit or damage the paint surface.
- When using a chemically treated cloth, follow the precautions included with the cloth.

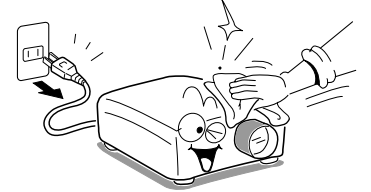

Trouble indications

The indicator lights and a beep sound inform you of internal abnormalities.

	<p>No power</p> <p>⇒ Problem with projector</p> <ul style="list-style-type: none"> • Unplug the power cord, and contact your dealer.
	<p>Lamp went out during use, or won't come on</p> <p>⇒ Lamp temperature is high so that it is difficult to turn on, the lifetime of the lamp has ended or the projector is malfunctioning.</p> <ul style="list-style-type: none"> • Unplug the power cord and wait for a short while, then turn the power back on. • If a lamp burns out, replace it with a new one. <p>✳ After approx. one minute of abnormal display, the projector returns to the standby state waiting for internal cool down.</p>
	<p>Power went out during use</p> <p>⇒ Internal overheating, or the outside temperature is too high.</p> <ul style="list-style-type: none"> • Place the projector so that the air intake and exhaust are not blocked. • Unplug the power cord and wait for a short while, then turn the power back on. <p>✳ The icon will appear before the power goes out.</p> <p>✳ After approx. one minute of abnormal display, the projector returns to the standby state waiting for internal cool down.</p>
	<p>Power went out during use</p> <p>⇒ Problem with internal cooling fan.</p> <ul style="list-style-type: none"> • Unplug the power cord, and contact your dealer. <p>✳ The icon will appear before the power goes out.</p> <p>✳ After approx. one minute of abnormal display, the projector returns to the standby state waiting for internal cool down.</p>
	<p>Power went out during use, or power won't come on</p> <p>⇒ The lamp cover is not properly attached.</p> <ul style="list-style-type: none"> • Unplug the power cord, and reattach the lamp cover. p.80 <p>✳ After approx. one minute of abnormal display, the projector returns to the standby state waiting for internal cool down.</p>
	<p>Power went out during use</p> <p>⇒ Problem inside the projector.</p> <ul style="list-style-type: none"> • Unplug the power cord and wait for a short while, then turn the power back on. • If the above action will not clear the problem, unplug the power cord, and contact your dealer. <p>✳ The icon will appear before the power goes out.</p> <p>✳ After approx. one minute of abnormal display, the projector returns to the standby state waiting for internal cool down.</p>

Before calling service personnel

If you think something is wrong, check the followings before contacting customer service. Please see "Trouble indications" [p.82](#) as well.

If This Happens	Check
No power	<ul style="list-style-type: none"> • Is the power cord plugged in? Is it connected to the projector? • Is the main power switch turned on? p.26 • Is the outer lamp cover attached properly? p.79
Power goes out during use	<ul style="list-style-type: none"> • Is the ambient temperature high? p.82 • Is the air intake or air exhaust blocked? p.82
No picture	<ul style="list-style-type: none"> • Is the projector turned on? (When [Auto input search] is [Off]) p.45 • Is the mute function on? p.32 • Is the brightness setting minimized? p.39 • Are the connections set up correctly? p.24 • Are all the connected devices functioning properly?
No audio	<ul style="list-style-type: none"> • Is the mute function on? p.32 • Is the volume setting minimized? p.29 • Are the connections set up correctly? p.24 • Are all the connected devices functioning properly?
Picture not displayed correctly	<ul style="list-style-type: none"> • Is the input signal supported by the projector? p.86 , p.87 • Is there something generating an abnormal video signal, for instance the video tape?
Picture blurred Part of picture out of focus	<ul style="list-style-type: none"> • Is the lens dirty? p.81 • Is the lens focus adjusted optimally? p.29 • Is the projection distance within the projector's supported range? p.22 • Is the projector's screen placement angle tilted too far? p.22 • Are the sharpness or sampling phase adjustments off? p.39
Image is dark	<ul style="list-style-type: none"> • Are the brightness or contrast adjustments off? p.39 • Is the lamp nearing the end of its service life? p.48
Colors too light Bad shading	<ul style="list-style-type: none"> • Are the color, tint, R-level, G-level, or B-level adjustments off? p.39 • Is the screen dirty? • Is the blackboard mode set properly? p.44 • Is the lamp nearing the end of its service life? p.48
Control panel key doesn't work	<ul style="list-style-type: none"> • Is the key lock function on? p.44
Remote control doesn't work	<ul style="list-style-type: none"> • Is the remote control ON/OFF switch set off? p.20 • Is the remote control code identical with the projector's code? p.45 • Are the remote control's batteries drained? • Are the batteries inserted into the remote control correctly? p.20 • Is the remote control being used within the effective range? p.20 • Are there any obstructions between the remote control and projector? • Are there any fluorescent or other bright lights shining at the projector's infrared remote sensor?

Before calling service personnel (Continued)

If This Happens	Check
USB memory images aren't projected	<ul style="list-style-type: none"> Is the USB memory inserted correctly? Is a USB memory not supported by the projector inserted? p.57 Are there any JPEG files saved on the USB memory? Are the files too large or in an unsupported format for the projector? Convert them with the supplied software application. p.71
Memory PC card images aren't projected	<ul style="list-style-type: none"> Is the memory PC card inserted correctly? Is a PC card not supported by the projector inserted? p.58 Is the CARD indicator red? p.23 Are there any JPEG files saved on the memory PC card? Are the files too large or in an unsupported format for the projector? Convert them with the supplied software application. p.71
The wireless LAN PC card doesn't work	<ul style="list-style-type: none"> Is the wireless LAN PC card inserted correctly? Is a wireless LAN PC card not supported by the projector inserted? The operation of cards other than the supplied product is not guaranteed. Is the CARD indicator red? p.23 Are the transmission mode and channel properly configured? p.54 Are there any obstructions between the computer and projector? Do your computer and OS support the supplied software application? p.65

Specifications

List of general specifications

Item	Specification	
Consumption Power	400 W	
Weight	5.5 kg	
External Dimensions (including protruding parts)	340 × 115 × 328 mm (W × H × D)	
Cabinet material	PC+ABS resin and ABS resin	
Conditions for usage environment	Temp: 5°C to 35°C; relative humidity: 30% to 70%	
Display pixels	1 chip DMD™	
Picture elements	786,432 pixels (1024H × 768V)	
Lens	Zoom lens F=2.4-3.0 f=21-31.5 mm (electric powered)	
Lamp	High-pressure mercury lamp (300 W)	
Projection screen size	33-300 inches	
Projection distance	1.17-13.76m	
Speaker	4 W + 4 W (stereo)	
Connection terminal	CONTROL terminal	LAN: 10BASE-T/100BASE-TX RS-232C: Mini DIN 8 pin
	COMPUTER(Y/PB/PR) 1 IN terminal	DVI-I: Analog RGB / Digital RGB / Y/PB/PR (dual use) AUDIO: 3.5mm dia. stereo mini-jack, 1.5 V (rms)
	COMPUTER(Y/PB/PR) 2 IN terminal	Mini D sub 15 pin Analog RGB / Y/PB/PR (dual use) AUDIO: 3.5mm dia. stereo mini-jack, 1.5 V (rms), 22 kΩ or more
	COMPUTER(Y/PB/PR) 3 IN terminal	G/Y: BNC Jack G: 0.7 V (p-p), 75Ω, Y: 1 V (p-p), 75Ω B/PB: BNC Jack 0.7 V (p-p), 75Ω R/PR: BNC Jack 0.7 V (p-p), 75Ω HD (Horizontal sync signal): BNC Jack TTL level (Pos/neg polarity) VD (Vertical sync signal): BNC Jack TTL level (Pos/neg polarity) AUDIO: 3.5mm dia. stereo mini-jack, 1.5 V (rms), 22 kΩ or more
	VIDEO IN terminal	S-VIDEO: Mini DIN 4 pin AUDIO (L/R): RCA Pin Jack × 2, 1.5 V (rms), 22 kΩ or more VIDEO: RCA Pin Jack, 1 V (p-p), 75Ω AUDIO (L/R): RCA Pin Jack × 2, 1.5 V (rms), 22 kΩ or more
	MONITOR OUT terminal	Mini D sub 15 pin RGB / Y/PB/PR (dual use)
	AUDIO OUT terminal	3.5mm dia. stereo mini-jack, 1.5 V (rms), 22 kΩ or more
	USB port	USB port USB 2.0 High-speed enabled Tape A; Output voltage: +5 VDC; Supply current: 500 mA
	PC card slot	Compliant with PC Card Standard TYPE II

Notes

- This model complies with the above specifications.
- Designs and specifications are subject to change without notice.
- This model may not be compatible with features and/or specifications that may be added in the future.

Separately sold product

Replacement Lamp Model TLPLW6 87

Specifications (Continued)

List of supported signals (RGB signals)

This projector supports the following RGB signals. Note, however, that depending on the computer model, the screen may show flicker or streaking. Please adjust the projector if this happens.

Resolution	Mode	Refresh rate (Hz)	H-frequency (kHz)	Clock (MHz)
720 x 400	720x400_85	85.039	37.927	35.500
640 x 480	VGA_60	59.940	31.469	25.175
	VGA_72	72.809	37.861	31.500
	VGA_75	75.000	37.500	31.500
	VGA_85	85.008	43.269	36.000
800 x 600	SVGA_56	56.250	35.156	36.000
	SVGA_60	60.317	37.879	40.000
	SVGA_72	72.188	48.077	50.000
	SVGA_75	75.000	46.875	49.500
	SVGA_85	85.061	53.674	56.250
832 x 624	MAC16"	74.550	49.725	57.283
1024 x 768	XGA_60	60.004	48.363	65.000
	XGA_70	70.069	56.476	75.000
	XGA_75	75.029	60.023	78.750
	XGA_85	84.997	68.667	94.500
	MAC19"	74.700	60.134	79.857
1152 x 864	SXGA1_75	75.000	67.500	108.000
1280 x 960	QuadVGA_60	60.000	60.000	108.000
	QuadVGA_85	85.002	85.938	148.500
1280 x 1024	SXGA3_60	60.020	63.981	108.000
	SXGA3_75	75.025	79.976	135.000
	SXGA3_85	85.024	91.146	157.500
* 1400 x 1050	SXGA+	59.978	65.317	121.750
* 1600 x 1200	UXGA_60	60.000	75.000	162.000
	UXGA_65	65.000	81.250	175.500
	UXGA_70	70.000	87.500	189.000
	UXGA_75	75.000	93.750	202.500
	UXGA_85	85.000	106.250	229.500

* Depending on the model of computer, the image may not be displayed properly with the DVI input.

Note

- Signals which resolution exceeds the native resolution (1024 × 768 pixels) will be compressed. For this reason, some information may be lost, or image quality may be affected.

List of supported signals (Y/P_B/P_R signals)

Signal format	fh(kHz)	fv(Hz)
* 480i(525i)@60Hz	15.73	59.94
480p(525p)@60Hz	31.47	59.94
* 576i(625i)@50Hz	15.63	50.00
576p(625p)@50Hz	31.25	50.00
720p(750p)@60Hz	45.00	60.00
720p(750p)@50Hz	37.50	50.00
1080i(1125i)@60Hz	33.75	60.00
1080i(1125i)@50Hz	28.13	50.00

* DVI digital input is not supported.

List of supported signals (Video, S-Video signals)

Video mode	fh(kHz)	fv(Hz)	fsc(MHz)
NTSC	15.73	60	3.58
PAL	15.63	50	4.43
SECAM	15.63	50	4.25 or 4.41
PAL-M	15.73	60	3.58
PAL-N	15.63	50	3.58
PAL-60	15.73	60	4.43
NTSC4.43	15.73	60	4.43

Pin assignment of COMPUTER-2 & MONITOR terminals

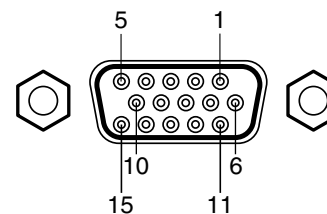

Mini D sub 15 Pin connector

Input Signal

- RGB input
 - RGB signals: 0.7V (p-p) 75 Ω
 - Horizontal sync signal: TTL level (Pos/neg polarity)
 - Vertical sync signal: TTL level (Pos/neg polarity)
- Y/P_B/P_R input
 - Y signal: 1.0V (p-p) 75 Ω
 - P_B/P_R signals: 0.7V (p-p) 75 Ω

Pin No.	Pin description	
	During RGB input	During Y/P _B /P _R input
1	Video signal (R)	Color difference signal (P _R)
2	Video signal (G)	Luminance signal (Y)
3	Video signal (B)	Color difference signal (P _B)
4	GND	*
5	GND	*
6	GND (R)	GND (P _R)
7	GND (G)	GND (Y)
8	GND (B)	GND (P _B)
9	N.C	*
10	GND	*
11	GND	*
12	N.C	*
13	Horizontal sync signal	*
14	Vertical sync signal	*
15	N.C	*

* Do not connect anything.

Specifications (Continued)

Pin assignment of DVI-I terminal

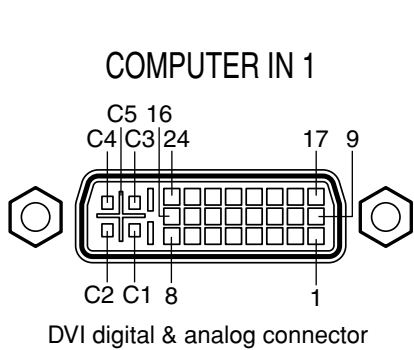

- Analog input signal
- Analog RGB input
 RGB signals: 0.7V (p-p) 75 Ω
 Horizontal sync signal: TTL level (Pos/neg polarity)
 Vertical sync signal: TTL level (Pos/neg polarity)
 - Y/P_B/P_R input
 Y signal: 1.0V (p-p) 75 Ω
 P_B/P_R signals: 0.7V (p-p) 75 Ω

Pin No.	Pin description
1	T.M.D.S. data 2 -
2	T.M.D.S. data 2 +
3	T.M.D.S. data 2/4 shielded
4	T.M.D.S. data 4 - (N.C)
5	T.M.D.S. data 4 + (N.C)
6	DDC clock
7	DDC data
8	Analog vertical sync signal
9	T.M.D.S. data 1 -
10	T.M.D.S. data 1 +
11	T.M.D.S. data 1/3 shielded
12	T.M.D.S. data 3 - (N.C)
13	T.M.D.S. data 3 + (N.C)
14	+5V power source
15	GND(+5V, H Sync & V Sync)

Pin No.	Pin description
16	Hot plug detection
17	T.M.D.S. data 0 -
18	T.M.D.S. data 0 +
19	T.M.D.S. data 0/5 shielded
20	T.M.D.S. data 5 - (N.C)
21	T.M.D.S. data 5 + (N.C)
22	T.M.D.S. clock shielded
23	T.M.D.S. clock +
24	T.M.D.S. clock -
C1	Analog video signal (R / P _R)
C2	Analog video signal (G / Y)
C3	Analog video signal (B / P _B)
C4	Analog horizontal sync signal
C5	Analog GND(R/P _R ,G/Y,B/P _B)

CONTROL terminal

Pin assignment

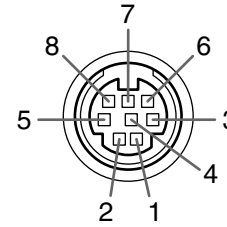

Mini DIN 8 pin connector

Pin No.	Signal Name	Description
1	RXD	Receiving data
2	CTS	Consent to send
3	DSR	Data set ready
4	GND	Signal ground
5	RTS	Request to send
6	N.C	No connection
7	TXD	Sending data
8	GND	Signal ground

Interface format

- Communication method RS-232C, 9600bps, No Parity, Data Length: 8 bits; Stop Bit Length: 1 bit
- Communication format

STX (02h)	Command (3Byte)	ETX (03h)
-----------	-----------------	-----------

Only 1 command valid per communication.
- Data format For input commands, only ASCII-compliant all-uppercase alphanumeric characters supported.
- Replies

Acknowledge	<table border="1"><tr><td>ACK (06h)</td><td>CR (0Dh)</td><td>Data</td></tr></table> ... Normally ended	ACK (06h)	CR (0Dh)	Data
ACK (06h)	CR (0Dh)	Data		
	<table border="1"><tr><td>ACK (06h)</td><td>ESC (1Bh)</td></tr></table> ... Aborted	ACK (06h)	ESC (1Bh)	
ACK (06h)	ESC (1Bh)			
No acknowledge	<table border="1"><tr><td>NAK (15h)</td></tr></table>	NAK (15h)		
NAK (15h)				

If commands are to be sent consecutively, wait for the response from the projector before sending the next command.

Main Commands

Item	Command
Power on	PON
Power off	POF
Icon display on	MO0
Icon display off	MO1
Auto setting (RGB input)	PAT
Status display on	DON
Status display off	DOF

Note

- Contact your dealer for control cable and other commands.

TOSHIBA CORPORATION